



 **Matis**

"Matis" d.o.o. - je kompanija osnovana 2002. godine sa ciljem da proizvodi nameštaj od pločastih materijala i vizijom da bude regionalni lider u proizvodnji i kvalitetu proizvoda. Kroz svaki komad našeg nameštaja, veoma lako ćete prepoznati principe kojim se rukovodi firma od osnivanja. Zato smo i usvojili slogan:

*"Matis" d.o.o. - was established in 2002 with the aim to produce furniture made of chip-board, with the vision to become regional leader in the production and quality of its products. Through each and every piece of furniture we make, you will easily recognize principles we follow in our business from the start. That's why we adopted the motto:*

**Oseti razliku!**

**Feel the difference!**

*Dragomir Lazović*

Dragomir Lazović

**SEDIŠTE:** SRBIJA / IVANJICA / Šume bb

**INFRASTRUKTURA**

5 fabričkih linija za serijsku proizvodnju pločastog nameštaja u Ivanjici

3 fabričke linije za proizvodnju tapaciranog nameštaja u Rumi

4 fabričke linije za serijsku proizvodnju nameštaja od masiva u Ivanjici

2 fabričke linije za serijsku proizvodnju dušeka u Ivanjici

**POVRŠINA:** 60000 m<sup>2</sup> proizvodnog i magacinskog kapaciteta

**MALOPRODAJA:** 35 maloprodajnih salona u zemlji i inostranstvu

**BROJ ZAPOSLENIH:** Preko 1050 zaposlenih. Prosečna starost 30 godina.

**TEHNOLOGIJA:** CNC / kompjuterski upravljane mašine

**HEADQUATERS:** SRBIJA / IVANJICA / Šume bb

**INFRASTRUCTURE**

5 chip-board furniture production lines in Ivanjica

3 upholstery production lines in Ruma

4 solid wood furniture production lines in Ivanjica

3 mattress production lines in Ivanjica

**USEFULL AREA:** 60000 m<sup>2</sup> covered in production lines and warehouses

**RETAIL:** 35 retail stores in Serbia and abroad

**EMPLOYEES:** Over 1050 employees. Average age 30 years old.

**TEHNOLOGY:** CNC

**KORPORATIVNI VIDEO KOMPANIJE MATIS:**

**CORPORATE VIDEO OF COMPANY MATIS:**

<https://www.youtube.com/watch?v=pj4gSyBXIGo>





52. međunarodni sajam nameštaja - 2015.



“Zlatni ključ” za najkvalitetniji proizvod u kategoriji  
Nameštaj za odmor (krevet, trosedi, dvosedi i fotelje) 2015.

Golden Key award for the best quality product in the category  
of seating furniture (beds, three-seaters, two-seaters and armchairs) 2015.



Biznis partner 2007 / Business Partner 2007.  
Najbolje srednje preduzeće u Srbiji za 2011.  
Pro Business leader in Serbia for 2011.  
Najbolje srednje preduzeće u Srbiji za 2012.  
Pro Business leader in Serbia for 2012.



Najdinamičniji razvoj u 2011. godini  
The most dynamic development in 2011.



Najbolji proizvođač kuhinja i  
kuhinjskog nameštaja u Srbiji za 2016.  
Best manufacturer of kitchen and  
kitchen furniture in Serbia for 2016.



Kvalitet proizvoda - Najbolja dečija soba Happy  
Beogradski sajam nameštaja 2011.  
Quality product - The best children room Happy  
Belgrade Furniture Fair 2011.



Nagrada za najbolje uređen štand  
Beogradski sajam nameštaja 2015.  
The prize for the best decorated stand  
Belgrade Furniture Fair 2015.



Nagrada za ukupan nastup i estetski izgled  
Beogradski sajam nameštaja 2014.  
The prize for overall performance  
and aesthetic appearance  
Belgrade Furniture Fair 2014.



Zlatna plaketa u kategoriji  
korporativni brend - Nameštaj 2015.  
Gold plaque in the category  
corporate brand - Furniture 2015.



Sertifikat bonitetne izvrsnosti - 2015.  
Certificate of Prudential Excellence - 2015.



Zlatni ključ - Nagrada za ukupan sajamski nastup  
Beogradski sajam nameštaja 2017.  
Golden key - Prize for total fair appearance  
Belgrade Furniture Fair 2017.



Sajamski ključ - Nagrada za višegodišnji doprinos  
podizanju kvaliteta manifestacije  
Beogradski sajam nameštaja 2018.  
Fair Key - Award for years of contribution  
improving the quality of the event  
Belgrade Furniture Fair 2018.





Cilj Matis D.O.O. je da postane i ostane vodeće preduzeće na tržištu u pogledu projektovanja, izrade, transporta, montaže i prodaje pločastog nameštaja i maloprodaje nameštaja, kućne tehnike i galanterije.

Ovaj cilj MATIS D.O.O. ostvaruje sprovođenjem i stalnim poboljšavanjem sistema menadžmenta kvalitetom usaglašenog sa sledećim standardima kvaliteta:

The goal of Matis doo is to become and to remain leading company in design, manufacturing, transport, mounting and sales of chipboard furniture, along with its retail network, selling furniture, home appliances and equipment.

This goal of Matis doo is realizing by implementing and constantly improving quality management system, in accordance with following quality standards:





Sa ponosom predstavljamo partnere i njihove materijale od kojih je sastavljen kompletan MATIS nameštaj.  
We are proud to present our business partners and their materials used to produce all MATIS furniture.

Frontovi iverica 18 mm <i>Front chipboards 18 mm</i>			Sjaj/Gloss 
Korpusi iverica 18 mm <i>Corps chipboards 18 mm</i>			
Radne ploče 38 i 28 mm <i>Worktops 38 i 28 mm</i>			
Ručice <i>Handles</i>			metal ili aluminijum <i>metal or aluminium</i>
Kant trake <i>Edge bands</i>		ABS 1 & 2 mm <a href="http://www.blazic.eu">www.blazic.eu</a> 	
Tehnologija izrade <i>Technology</i>			
Tehnologija lepljenja <i>Adhesives technology</i>			
Okovi <i>Okovi</i>			 
Matis profili <i>MDF battens</i>		Rasveta <i>Lighting</i>	



# Sadržaj

## Contents

Elegance line program .....	08-33
<i>Kuhinje/Kitchens</i>	
<i>Predsooblja/Hall units</i>	
<i>Dnevni boravak/Living room</i>	
<i>AP plakari/AP wardrobes</i>	
<i>Ormari sa klasičnim otvaranjem/Classic opening wardrobes</i>	
<i>Komode i noćni ormarići/Cupboards and nighstands</i>	
<i>Kuhinje/Kitchens</i> .....	34-61
<i>Stolovi i stolice/Dining tables and chairs</i> .....	62-65
<i>Predsooblja/Hall units</i> .....	66-75
<i>TV komode i komode/TV stands and cupboards</i> .....	76-81
<i>Klub stolovi/Club tables</i> .....	82-83
<i>Dnevne sobe/Living rooms</i> .....	84-91
<i>Spavaće sobe/Bed rooms</i> .....	92-95
<i>Garderoberi/Wardrobes</i> .....	96-105
<i>Noćni ormarići/Nightstands</i> .....	106-107
<i>Kreveti/Beds</i> .....	108-121
<i>Dečije sobe/Children rooms</i> .....	122-139
<i>Kompjuterski stolovi/Computers desk</i> .....	140-141
<i>O nama/About us</i> .....	142-144



## KUHINJE ELEGANCE LINE/*ELEGANCE LINE KITCHEN*

Nova linija kuhinja odiše dizajnerskom elegancijom i svakodnevnom praktičnošću. Sistem elemenata inspirisan kuhinjama po meri, projektovan je tako da maksimalno iskoristi svaki prostor u kome se zatekne. Kombinacijom elemenata se pored tipičnih fortalnih i ugaonih kuhinja, mogu postići i dve dubine kod visećih kuhinjskih elemenata i dve visine kompletne kuhinje, na 220cm i na 255cm - tako da se znatno povećava njen ostavinski prostor. Pored novih elemenata u vidu nisa i vinarija, ova kuhinja omogućava izuzetno veliki broj kombinacija sa elementima širine 60cm i 80 cm. Uveden je novi drveni dekor - halifax hrast koji je rađen u sinkro pore tehnologiji, koja imitira relistične pore i strukturu drveta.

Posebno smo ponosni na nasu saradnju sa BLUM-om, koji je jedan od vodećih proizvođača okova i mehanizama u svetu. Svi mehanizmi i šarke su BLUM sa 25-o godišnjom garancijom.



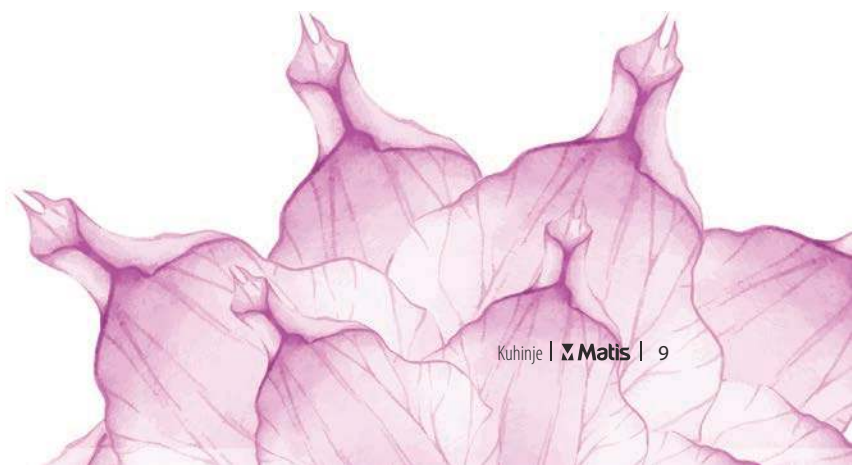





## KUHINJE ELEGANCE LINE/ELEGANCE LINE KITCHEN

*Our new line of kitchens are fully emphasizing functionality and design elegance. System of elements, inspired with custom-made kitchens, is designed in order to fully utilize each space furnished with these items. Combining elements in different ways we can create not only typical frontal and corner kitchens but also double depth upper kitchen elements and double height of the complete kitchen, on 220cm and 255cm- significantly enlarging stock space. Moreover, there are new elements such as wine and alcove stock space, providing huge number of configurations with elements of 60cm and 80cm in width. Kitchen is enriched with new wooden decor element- halifax oak, made in sincroporas technology, imitating realistic poras and wood structure. We are very proud of our cooperation with BLUM company, one of the leading producers of furniture fittings and mechanisms in the world. All mechanisms and fittings are products of BLUM, with 25 years of warranty.*





*elegance line*  
by Matis

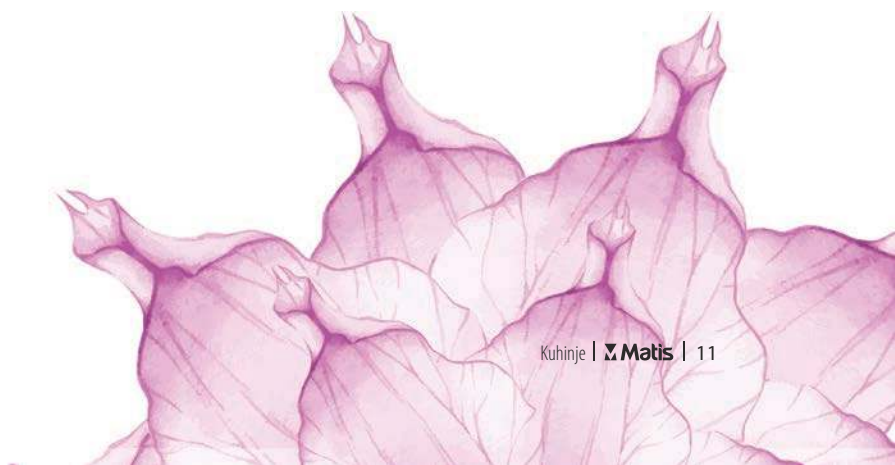







**blum**  
MEHANIZMI

**blum**  
MEHANIZMI

**blum**  
MEHANIZMI

**Diht lajsna PVC**

pietra mermer, aida orah, san remo, aurora bianco, bež, arkosa pesak

**PVC upsand**

pietra marble, aida walnut, decor marble, san remo, aurora bianco, beige, sand arcossa

4 m



- ID KDLK024
- ID KDL3704
- ID KDL624
- ID KDL166
- ID KDL104
- ID KDL276

**Gola profil**

Gola profil se naručuje zasebno.  
Gola profile is ordered separately.

2, 3, 4 m



- ID KEL2M
- ID KEL3M
- ID KEL4M

Završetak za Gola profil se naručuje zasebno.  
Gola profile finishing parts are ordered separately.

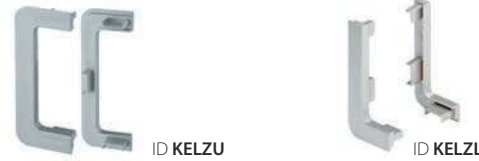

ID KELZU

ID KELZL

**Podna lajsna PVC bela, siva**  
Plinth white, gray

2 m  
3 m  
4 m



bela  
white

- ID 070909 - 2m + 2 ugaonika/corners
- ID 071109 - 3m + 3 ugaonika/corners
- ID 071009 - 4m + 4 ugaonika/corners



siva metalik  
grey metallic

- ID 070922 - 2m + 2 ugaonika/corners
- ID 071122 - 3m + 3 ugaonika/corners
- ID 071022 - 4m + 4 ugaonika/corners

NAPOMENA: Kompletna šifra elementa se dobija zamenom zvezdica \*\* sa dve cifre iz prikazanih dezena.  
NOTE: The complete code of an element is obtained by replacing stars\*\* with two digits of the displayed pattern.



\*\*

Radna ploča / Worktop

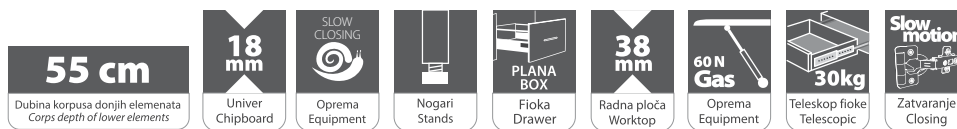



**V15/70**  
15x32x70 cm  
ID KEV 1570\*\*

**V20/70**  
20x32x70 cm  
ID KEV 2070\*\*

**V15/105**  
15x32x105 cm  
ID KEV 15105\*\*

**V20/105**  
20x32x105 cm  
ID KEV 20105\*\*



**VIN 60x15**  
60x32x15 cm  
ID KEVIN 60\*\*



**VIN 80x15**  
80x32x15 cm  
ID KEVIN 80\*\*



**NIŠA 60x35**  
60x32x35 cm  
ID KENIŠA 6035\*\*



**NIŠA 80x35**  
80x32x35 cm  
ID KENIŠA 8035\*\*



**VH60/35**  
60x60x35 cm  
ID KEVH 6035\*\*



**TOP V60/35**  
60x60x35 cm  
ID KETOP 6035\*\*



**VH80/35**  
80x32x35 cm  
ID KEVH 8035\*\*



**TOP V80/35**  
80x60x35 cm  
ID KETOP 8035\*\*



**VH60**  
60x32x70 cm  
ID KEVH 60\*\*

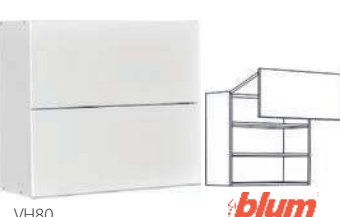

**VH80**  
80x32x70 cm  
ID KEVH 80\*\*



**VH60/S**  
60x32x70 cm  
ID KEVH 60S\*\*

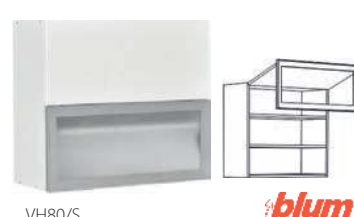

**VH80/S**  
80x32x70 cm  
ID KEVH 80S\*\*



**V60**  
60x32x70 cm  
ID KEV 60\*\*



**V80**  
80x32x70 cm  
ID KEV 80\*\*



**VA60/31**  
60x32x31 cm  
ID KEVA 6031\*\*



**VA60/20**  
60x32x20 cm  
ID KEVA 6020\*\*



**VU**  
60/32x60/32x70 cm  
ID KEVU 60\*\*



**D 60RV**  
60x60x222 cm  
ID KED 60RV\*\*



**FRIZ 2V**  
60x60x222 cm  
ID KEFRIZ 2V\*\*

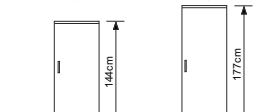
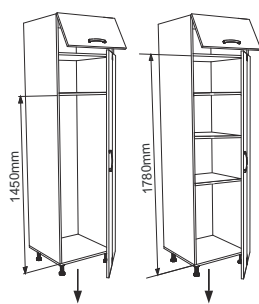

\* dimenzije frižidera \* fridge dimension



**FRIZ 3V**  
60x60x222 cm  
ID KEFRIZ 3V\*\*

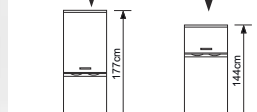
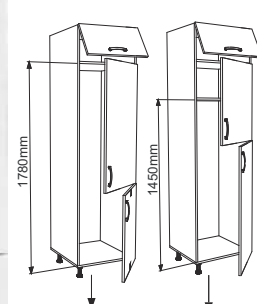

\* dimenzije frižidera \* fridge dimension





**D15**  
15x60x85 cm  
ID KED 15\*\*



**D20**  
20x60x85 cm  
ID KED 20\*\*



**D60**  
60x60x85 cm  
ID KED 60\*\*



**D60 2F**  
60x60x85 cm<sup>3</sup>  
ID KED 602F\*\*



**D60 3F**  
60x60x85 cm  
ID KED 603F\*\*

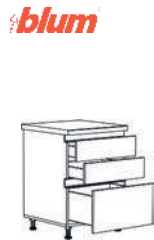

**D80 2F**  
80x60x85 cm  
ID KED 802F\*\*



**D80 3F**  
80x60x85 cm  
ID KED 803F\*\*



**D80**  
80x60x85 cm  
ID KED 80\*\*



**DU120**  
120x60x85 cm  
ID KEDU 120\*\*



**DU 2K**  
120/60x80/60x85 cm  
ID KEDU 2K\*\*



**D60 R**  
60x60x85 cm  
ID KED60R\*\*

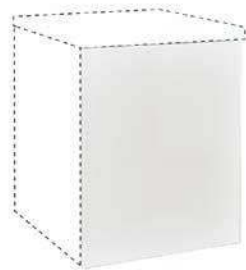

**MASKA 60x72**  
60 x 72 x 1.8 cm  
ID KEMAS60X72



**MASKA 60x60**  
60 x 60 x 1.8 cm  
ID KEMAS60X60





## PREDSOBLJA/HALL UNITS

Za ljubitelje klasične lepote i vanvremenskih dizajnerskih formi proširili smo Rustik kolekciju nameštaja. Znate nas već po nagrađivanim i dokazano kvalitetnim Rustik kuhinjama, koje su osvojile srca i i ukrasile mnoge domove naših vernih kupaca. Sada Vam predstavljamo novo Rustik predsoblje.

Sačinjeno je od pet elemenata i projektovano tako da podržava i ispunjava sve neophodne funkcije nameštaja za predsoblje. Svuda su većinski postavljene police pomerljive po visini, kako bi se lagodno skladištila obuća svih gabarita. Frontovi i vertikalne dekorativne lajsne su načinjeni od medijapana presvučenog ruštik folijom na italijanskoj vakuum presi, sa izuzetkom dekorativne rustik lajsne ispod plafona koja se izrađuje od drveta.

*Series of hall units Elegance are bringing the system of elements made in various widths, that can guaranty more than 90% of fitting into any entrance hall space. Shoe cabinets and hangers in various dimensions, with multiple purpose hall wardrobe, that can be used both shoe cabinet and hanger or both combined.*

*These items are made in two decor combinations, one in classical and timeless beauty of white-white mat corps and white gloss fronts with handles in high gloss made of polished aluminium. The other combination of decor is innovative wooden decor in gray shades, with fronts in high gloss and colour popularly named sandgloss. Elegance entrance hall units are made in classical design manners, with functionality and almost limitless options of fitting elements into various space width.*

*elegance line*  
by Matis



**Ormar 80/Wardrobe 80**  
80 x 38 x 208,5 cm



**ID 120114**  
belo sjaj/ white gloss



**ID 120256**  
nordic hrast-pesak sjaj/  
nordic oak-sand gloss

**Ormar 80 o (sa ogledalom)/Wardrobe with mirror**  
80 x 38 x 208,5 cm



**ID 120314**  
belo sjaj/ white gloss



**ID 120456**  
nordic hrast-pesak sjaj/  
nordic oak-sand gloss

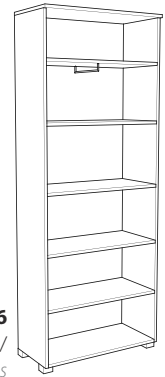

**Ormar 30/Wardrobe 30**  
30 x 38 x 208,5 cm



**ID 120514**  
belo sjaj/ white gloss



**ID 120656**  
nordic hrast-pesak sjaj/  
nordic oak-sand gloss

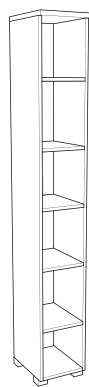

**Komoda sa čivilukom 80/Cupboard with haner 80**  
80 x 38 x 208,5 cm



**ID 120714**  
belo sjaj/ white gloss



**ID 120856**  
nordic hrast-pesak sjaj/  
nordic oak-sand gloss

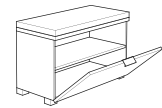
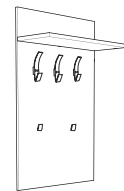

**Čiviluk/Haneger**  
40 x 199 x 30,6 cm



**ID 121314**  
belo sjaj/  
white gloss



**ID 121456**  
nordic hrast-pesak sjaj/  
nordic oak-sand gloss

**Cipelar 60/Shoe cabinets 60**  
60x38x107.5cm



**ID 120914**  
belo sjaj/ white gloss



**ID 121056**  
nordic hrast-pesak sjaj/  
nordic oak-sand gloss



**Cipelar 80/Shoe cabinets 80**  
80x38x107.5cm



**ID 121114**  
belo sjaj/ white gloss



**ID 121256**  
nordic hrast-pesak sjaj/  
nordic oak-sand gloss

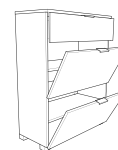

**Ogledalo/Mirror**  
80 x 2 x 60 cm



**ID 121514**  
belo sjaj/ white gloss

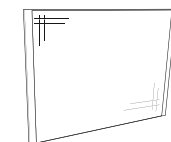

**ID 121656**  
nordic hrast/nordic oak-



Belo sjaj  
White gloss



Nordic hrast-pesak sjaj  
Nordic oak-sand gloss

Visoki sjaj/High gloss

**FUNDERMAX**





## KOMBINACIJE

- ① Ormar 30/Wardrobe 30
- ② Čiviluk 40/Hanger 40
- ③ Komoda sa čivilukom 80/Cupboard with hanger 80
- ④ Ogledalo /Mirror
- ⑤ Cipelar 60 /Shoe cabinet 60
- ⑥ Cipelar 80 /Shoe cabinet 80

*elegance line*  
by Matis





## KOMBINACIJE

- ① Ormar 30/Wardrobe 30
- ② Čiviluk 40/Hanger 40
- ③ Komoda sa čivilukom 80/Cupboard with hanger 80
- ④ Ogledalo /Mirror
- ⑤ Ormar 80 O/Wardrobe 80 O
- ⑥ Cipelar 80 /Shoe cabinet 80

*elegance line*  
by Matis



## ELEGANCE LINE PLAKARI / *ELEGANCE LINE WARDROBES*

Idealno rešenje koje pomiruje elegantnu dizajnersku formu i maksimalno iskorišćenje prostora. Unutrašnjost plakara je veoma praktično isplanirana i podeljena je na 3 dela. Fioke su postavljene unutar plakara na metalnim teleskopskim klizačima. Delovi za kačenje duže i kraće garderobe poseduju mobilnu garderobnu šipku od poliranog aluminijuma. Treća zona su pomerljive police koje omogućavaju različite kombinacije u rasporedu unutar plakara. Krila plakara se prave od univera u visokom sjaju, debljine 18mm, sa ukrutnim horizontalnim alu-sjaj lajsnama i Hettich kliznim mehanizmom sa soft-close dodatkom. Rukohvati su izrađeni od poliranog aluminijuma u visokom sjaju. Rasveta je opciona, led lampe se šrafe u plafon plakara i pale se na prekidač koji se dobija uz kupljeni set rasvete.

Krila se montiraju u fabrici što garantuje čvrstinu i stabilnost na duže staze. Rade se iz tri dela sa vertikalnim ukrutnim lajsnama čime je sprečeno krivljenje frontova tokom vremena. Zadržali smo proverni sistem nivelacije u 6 tačaka, jedino kod plakara AP 270 se visinski podesava u 8 tačaka zbog njene dužine.

Zadržali smo proverni sistem nivelacije u 6 tačaka, jedino kod plakara AP 270 se visinski podesava u 8 tačaka zbog svoje dužine.



*elegance line*  
by Matis





# AP 270 PLAKAR / WARDROBES AP 270

dimenzija/dimension: 269 x 64 x 221,5 cm



ID 320114  
belo sjaj / white gloss



optional lighting



ID 070118  
rasveta/lighting

**FURNIKA**  
*Light created with passion*



ID 320256  
nordic hrast-pesak sjaj /  
nordic oak-sand gloss

# AP 270 O PLAKAR / WARDROBES AP 270 O

dimenzija/dimension: 269 x 64 x 221,5 cm



ID 321014  
belo sjaj / white gloss



optional lighting



ID 070118  
rasveta/lighting

**FURNIKA**  
*Light created with passion*



ID 322056  
nordic hrast-pesak sjaj /  
nordic oak-sand gloss

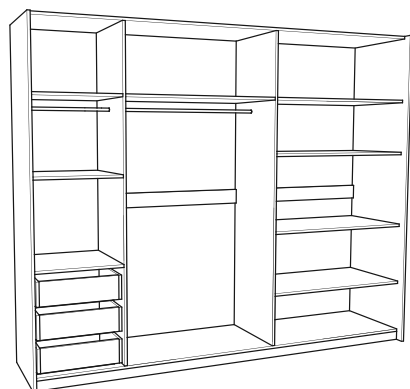

**Hettich**  
GERMANY



## Podešavanje / Adjusting

**LAKA NIVELACIJA** - Nivelacija poda ormara na 6 tačaka

Ispod poda ormara je ugrađeno 6 nogarića za lako besprekorno nivelisanje poda ormara. To je važno jer se u toku eksploatacije vrata veoma lako i beščujno otvaraju, a uz pomoć ugrađenog SlowMotion mehanizma, veoma lako i usporeno zatvaraju.

**EASY LEVELING** - Leveling the closet floor on 6 points  
Below the wardrobe floor legs for easy leveling are installed. This is important for easy and silent door opening, and with the integrated Slow-Motion mechanism, very easy and slow closing.



Belo sjaj  
White gloss



Nordic hrast-pesak sjaj  
Nordic oak-sand gloss

Visoki sjaj/High gloss  
**FUNDERMAX**  
AUSTRIA



## AMERIČKI PLAKARI / SLIDING WARDROBES

This is an ideal solution satisfying both design sides - elegant form and the maximum utilization of the space available. Inner part of the wardrobe is carefully planned and divided into 3 parts. Drawers are placed inside on the system of metal telescopic sliders. Parts planned for stacking of longer and shorter cloth items are equipped with an extra hanger made of polished aluminium. The third zone consists of drawers providing various configuration options inside the wardrobe. Wardrobe fronts are made of high gloss chipboard, 18mm thick, with stabilizing horizontal alu-gloss battens and Hettich sliding mechanism with soft-close mechanism. Handles are made of polished aluminium in high gloss. Lighting is optional, led lamps can be placed into wardrobe ceiling, LED lamps switch is a part of lighting set bought.

Fronts are mounted in the factory that is guaranty of firmness and long-term stability. Fronts are made in three parts, with vertical stabilizing battens, preventing fronts from folding during time. We have preserved adjusting testing system in 6 points, with an exception of AP 270 wardrobe that is adjusted in height in 8 points for its length dimension.

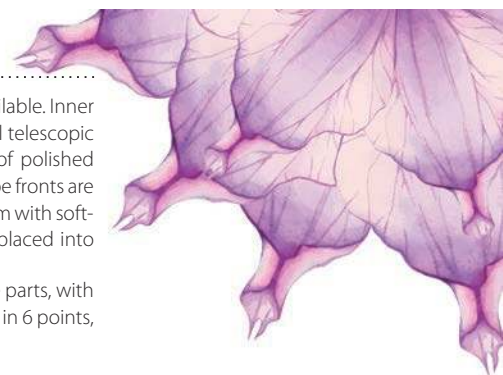

*elegance line*  
by Matis



# AP 230 PLAKAR/WARDROBES AP 230

dimenzija/dimension: 229 x 64 x 221,5 cm



ID 320514  
belo sjaj/ white gloss



optional lighting



ID 070118  
rasveta/lighting

**FURNIKA**  
*Light created with passion*



ID 320656  
nordic hrast-pesak sjaj/  
nordic oak-sand gloss

# AP 230 O PLAKAR/WARDROBES AP 230 O

dimenzija/dimension: 229 x 64 x 221,5 cm



ID 325014  
belo sjaj/ white gloss



optional lighting



ID 070118  
rasveta/lighting

**FURNIKA**  
*Light created with passion*



ID 326056  
nordic hrast-pesak sjaj/  
nordic oak-sand gloss

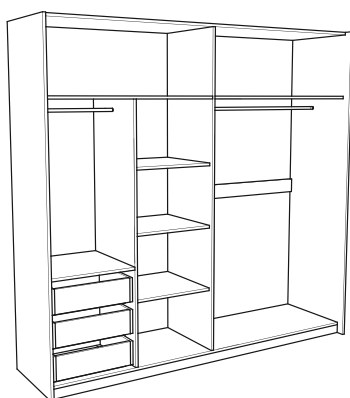

MEHANIZAM

**Hettich**  
GERMANY

MECHANISM



Belo sjaj  
White gloss



Nordic hrast-pesak sjaj  
Nordic oak-sand gloss

Visoki sjaj/High gloss  
**FUNDERMAX**  
AUSTRIA





## AMERIČKI PLAKARI / *SLIDING WARDROBES*

Idealno rešenje koje pomiruje elegantnu dizajnersku formu i maksimalno iskorišćenje prostora. Unutrašnjost plakara je veoma praktično isplanirana i podeljena je na 3 dela. Fioke su postavljene unutar plakara na metalnim teleskopskim klizačima. Delovi za kačenje duže i kraće garderobe poseduju mobilnu garderobnu šipku od poliranog aluminijuma. Treća zona su pomerljive police koje omogućavaju različite kombinacije u rasporedu unutar plakara. Krila plakara se prave od univera u visokom sjaju, debljine 18mm, sa ukrutnim horizontalnim alu-sjaj lajsnama i Hettich kliznim mehanizmom sa soft-close dodatkom. Rukohvati su izrađeni od poliranog aluminijuma u visokom sjaju. Rasveta je opciona, led lampe se šrafe u plafon plakara i pale se na prekidač koji se dobija uz kupljeni set rasvete.

Krila se montiraju u fabrici što garantuje čvrstinu i stabilnost na duže staze. Rade se iz tri dela sa vertikalnim ukrutnim lajsnama čime je sprečeno krivljenje frontova tokom vremena. Zadržali smo proverni sistem nivelacije u 6 tačaka, jedino kod plakara AP 270 se visinski podesava u 8 tačaka zbog njegove dužine.

Zadržali smo proverni sistem nivelacije u 6 tačaka, jedino kod plakara AP 270 se visinski podesava u 8 tačaka zbog svoje dužine.



*elegance line*  
by Matis

# AP 180 PLAKAR / WARDROBES AP 180

dimenzija/dimension: 179 x 64 x 221,5 cm



ID 320314  
belo sjaj / white gloss



optional lighting



ID 070118  
rasveta/lighting



ID 320456  
nordic hrast-pesak sjaj /  
nordic oak-sand gloss

# AP 180 O PLAKAR / WARDROBES AP 180 O

dimenzija/dimension: 179 x 64 x 221,5 cm



ID 323014  
belo sjaj / white gloss



optional lighting



ID 070118  
rasveta/lighting



ID 324056  
nordic hrast-pesak sjaj /  
nordic oak-sand gloss

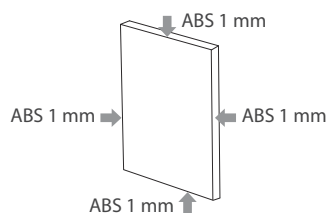
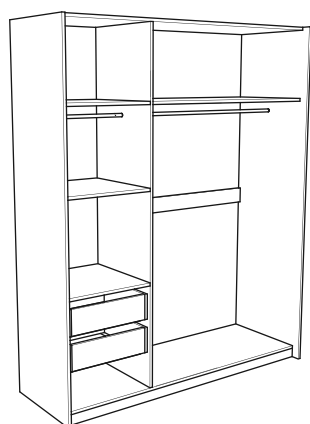

FRONTOVI KANTOVANI SA 4 STRANE  
Four side edge banding of front doors

Visoki sjaj / High gloss



Belo sjaj  
White gloss



Nordic hrast-pesak sjaj  
Nordic oak-sand gloss

Visoki sjaj / High gloss  
**FUNDERMAX**  
AUSTRIA



## ORMARI SA KLASIČNIM OTVARANJEM/ WARDROBES WITH CLASSICAL OPENING

Svi plakari kolekcije Elegance se mogu kombinovati sa ostatkom istoimenog asortimana, čime se dobija funkcionalna i elegantna spavaća soba sa dosta prostora za odlaganje garderobe. Sve komode i noćni ormarići su dizajnirani i projektovani tako da idelano prate liniju plakara. Metalni teleskopski klizači na svim fiokama omogućavaju njihovo potpuno izvlačenje i time veću preglednost sadržaja u njima. Frontovi od univera 18mm u visokom sjaju se nose na šarkama sa usporivačima. Kvalitetne ručice od poliranog aluminijuma i izuzetne završne obrade na jedinstven način oplemenjuju kompletnu seriju Elegance plakara i komoda. Rasveta za svaki pojedinačni element je uključena u cenu. Uz rasvetu dobijate trafo i prekidač. Radi se u dve kombinacije dekora, beli mat korpusi - belo sjaj frontovi i nordic wood korpusi - pesak sjaj frontovi.





# ORMAR 180/WARDROBES 180

dimenzija/dimension: 180 x 60 x 220 cm



ID **J520314**  
belo sjaj/ white gloss



lighting is included in price



ID **J520356**  
nordic hrast-pesak sjaj/  
nordic oak-sand gloss

# ORMAR 180 O/WARDROBES 180 O

dimenzija/dimension: 180 x 60 x 220 cm



ID **J523014**  
belo sjaj/ white gloss



lighting is included in price



ID **J523056**  
nordic hrast-pesak sjaj/  
nordic oak-sand gloss

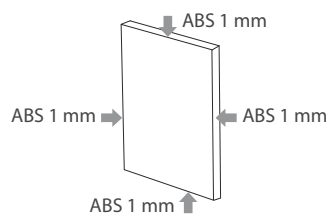
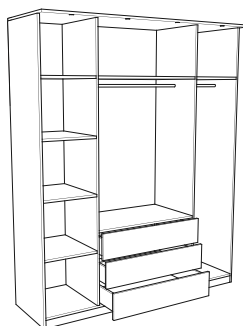

FRONTOVI KANTOVANI SA 4 STRANE  
Four side edge banding of front doors

Visoki sjaj/High gloss



Belo sjaj  
White gloss



Nordic hrast-pesak sjaj  
Nordic oak-sand gloss

Visoki sjaj/High gloss  
**FUNDERMAX**  
AUSTRIA



## ORMARI SA KLASIČNIM OTVARANJEM/ WARDROBES WITH CLASSICAL OPENING

All wardrobes of the collection ELEGANCE can be easily combined with other items of the same assortment line, creating your elegant and functional bedroom with lots of space for your cloth items. All commodes and nightstands are designed and projected in order to follow the wardrobe line in an ideal manner. Metal telescopic sliders on every single drawer are enabling better review of the content and complete opening. Fronts are 18mm thick, made of high gloss chipboard on sliders with decelerators. High quality handles made of polished aluminium with an exceptional final processing are enriching complete series of Elegance wardrobes and commodes. Lighting for each single element is included in price. With this set you will get switch and transformer as well. This line is made in two decor combinations, mat white corps - white gloss fronts and nordic wood corps - sand gloss corps.



*elegance line*  
by Matis



## ORMAR 135/WARDROBES 135

dimenzija/dimension: 135 x 60 x 220 cm



ID **J520214**  
belo sjaj/ white gloss



ID **J520256**  
nordic hrast-pesak sjaj/  
nordic oak-sand gloss



**rasveta**  
je uključena  
u cenu

lighting is included in price

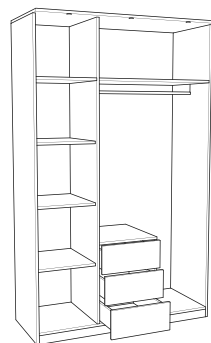

## ORMAR 135 0/WARDROBES 135 0

dimenzija/dimension: 135 x 60 x 220 cm



ID **J522014**  
belo sjaj/ white gloss



ID **J522056**  
nordic hrast-pesak sjaj/  
nordic oak-sand gloss



**rasveta**  
je uključena  
u cenu

lighting is included in price

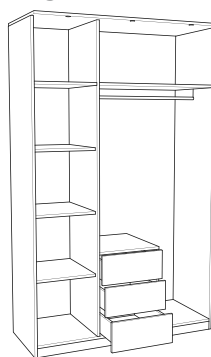

## ORMAR 90/WARDROBES 90

dimenzija/dimension: 90 x 60 x 220 cm



ID **J520114**  
belo sjaj/ white gloss



ID **J520156**  
nordic hrast-pesak sjaj/  
nordic oak-sand gloss



**rasveta**  
je uključena  
u cenu

lighting is included in price

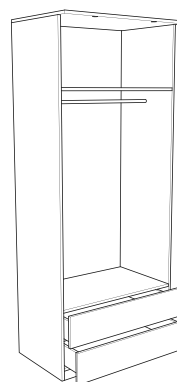

Belo sjaj  
White gloss



Nordic hrast-pesak sjaj  
Nordic oak-sand gloss

Visoki sjaj/High gloss

**FUNDERMAX**

AUSTRIA



## KOMODE I NOĆNI ORMARIĆI

### STANDS AND NIGHTSTANDS

Dizajnerski osvežen prateći program komoda i noćnih ormarića savršeno upotpunjuje Elegance line liniju nameštaja. Za noćne ormariće i komodu Elegance 4F ponudili smo i opcionalnu ambijentalnu led rasvetu sa peskirnim staklom, idealan tip osvetljenja uz koje se u večernjim satima opuštate gledajući tv. Minimalistički dizajn, u kombinaciji sa frontovima u visokom sjaju, upotpunjen je elegantnom ručicom od poliranog aluminijuma i metalnim teleskopskim klizačima. Program komoda i noćnih ormarića Elegance line je kreiran tako da idealno prijanja uz istoimene spavaće sobe i dnevni boravak, ali svojom lepotom i jednostavnošću se može lako prilagoditi i u bilo kom drugom enterijeru.

*Dizajnerski osvežen prateći program komoda i noćnih ormarića savršeno upotpunjuje Elegance line liniju nameštaja. Za noćne ormariće i komodu Elegance 4F ponudili smo i opcionalnu ambijentalnu led rasvetu sa peskirnim staklom, idealan tip osvetljenja uz koje se u večernjim satima opuštate gledajući tv. Minimalistički dizajn, u kombinaciji sa frontovima u visokom sjaju, upotpunjen je elegantnom ručicom od poliranog aluminijuma i metalnim teleskopskim klizačima. Program komoda i noćnih ormarića Elegance line je kreiran tako da idealno prijanja uz istoimene spavaće sobe i dnevni boravak, ali svojom lepotom i jednostavnošću se može lako prilagoditi i u bilo kom drugom enterijeru.*

*elegance line*  
by Matis





## KOMODA 4F/CUPBOARD 4F

dimenzija/dimension: 90 x 48 x 87 cm



ID **J360114**  
belo sjaj/ white gloss



OPCIONO  
rasveta

optional lighting

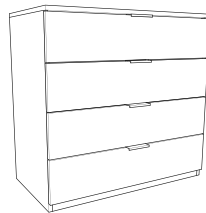

ID **070120**  
rasveta/lighting



ID **J360256**  
nordic hrast-pesak sjaj/  
nordic oak-sand gloss

## NOĆNI ORMARIĆI/NIGHTSTANDS

Matis 3F  
45x38x67cm



OPCIONO  
rasveta

optional lighting



ID **J360514**  
belo sjaj/ white gloss

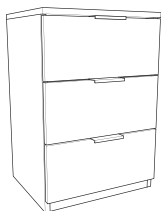

ID **070119**  
rasveta/lighting



ID **J360656**  
nordic hrast-pesak sjaj/  
nordic oak-sand gloss

Matis 2F  
45x38x46,5cm



OPCIONO  
rasveta

optional lighting



ID **J360314**  
belo sjaj/ white gloss

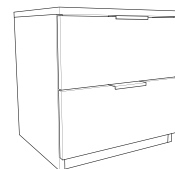

ID **070119**  
rasveta/lighting



ID **J360456**  
nordic hrast-pesak sjaj/  
nordic oak-sand gloss



Belo sjaj  
White gloss



Nordic hrast-pesak sjaj  
Nordic oak-sand gloss

Visoki sjaj/High gloss

**FUNDERMAX**

AUSTRIA





## KOMODA 150 / STANDS 150

Jedna od glavnih odlika Elegance line komode 150 je njena svršena podela raspoloživog prostora koja joj omogućava višestruku primenu u enterijeru. Može služiti kao tv komoda, komoda u spavaćim sobama za odlaganje garderobe ili kao klasična komoda u bilo kom delu stana. Otvorena niša u sredini komode, tri duboke fioke oslonjene na metalnim teleskopskim klizačima i dva zasebna bočna prostora sa pomerljivom policom unutra, pružiće Vam najrazličitije mogućnosti. Radi se u dve kombinacije dekora, beli mat korpusi - belo sjaj frontovi i nordic wood korpusi - pesak sjaj frontovi.

Jedna od glavnih odlika Elegance line komode 150 je njena svršena podela raspoloživog prostora koja joj omogućava višestruku primenu u enterijeru. Može služiti kao tv komoda, komoda u spavaćim sobama za odlaganje garderobe ili kao klasična komoda u bilo kom delu stana. Otvorena niša u sredini komode, tri duboke fioke oslonjene na metalnim teleskopskim klizačima i dva zasebna bočna prostora sa pomerljivom policom unutra, pružiće Vam najrazličitije mogućnosti. Radi se u dve kombinacije dekora, beli mat korpusi - belo sjaj frontovi i nordic wood korpusi - pesak sjaj frontovi.

*elegance line*  
by Matis



# KOMODA 150/CUPBOARD 150

dimenzija/dimension: 150 x 38 x 87 cm



ID **J200114**  
belo sjaj/ white gloss



ID **J200156**  
nordic hrast-pesak sjaj/  
nordic oak-sand gloss

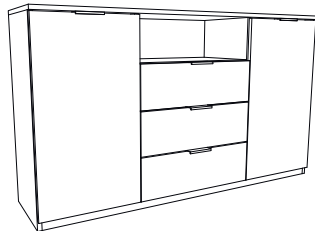

Belo sjaj  
White gloss



Nordic hrast-pesak sjaj  
Nordic oak-sand gloss

Visoki sjaj/High gloss

**FUNDERMAX**

AUSTRIA







## KUHINJE RUSTIK/*RUSTIC KITCHEN*

Kuhinja predstavlja istinsko srce svakog doma. Stoga, kompanija Matis je pred sebe postavila izazov da Vam ponudi modernu i elegantnu kuhinju, koja će istovremeno buditi toplinu tradicionalnog porodičnog domaćinstva - tako je nastala kuhinja Rustik. Izrađena od medijapana (MDF-a) presvučenog PVC folijom, kuhinja Rustik spada u sam vrh kada je kvalitet u pitanju. Ono što kuhinju Rustik dodatno izdvaja je njen jedinstveni rustični dizajn, sa specijalno izrađenim ručicama od metala i drveta. Uverite se i sami zašto su kuhinje Rustik osvojile domaće tržište.

*The kitchen represents the true heart of every home. Therefore, the company Matis faced a challenge to offer you modern and elegant cuisine, which at the same time will awaken the warmth of a traditional family household - so kitchen Rustic was created. Made of MDF-coated PVC foil, RustiC kitchens belong to the very top when quality is concerned. What kitchens RustiC extracts is their unique rustic design, with handles with a specially made wood-metal combination just for this product line. Check out why kitchens Rustic a hit on the domestic market.*





Dobitnik nagrade za kvalitet u proizvodnji kuhinja!  
The winner of the award for kitchen production quality!



Made in  
**Serbia**





## KUHINJE RUSTIK/*RUSTIC KITCHEN*

Spoj tradicionalnog i modernog izgleda idealan je za sve vrste domova. Frontovi su izrađeni od medijapana 19 mm i tretirani savremenom italijanskom vakum tehnologijom. Završna obrada na vakum presi je precizno zalepljena PVC folija, koja je otpornija na habanje i udarce. U upotrebi su kvalitetni okovi i šarke sa usporivačima koji štite proizvod na duže staze.

*Traditional and modern looks ideal for all types of homes. Fronts are made of 19mm MDF and equipped with silent and "slow" closing system that prevents damage. Fronts are made by Italian vacuum technology. Quality of fittings guarantees quality and functionality.*







## RUSTIK kuhinja sa pultom / *RUSTIC kitchen with counter*

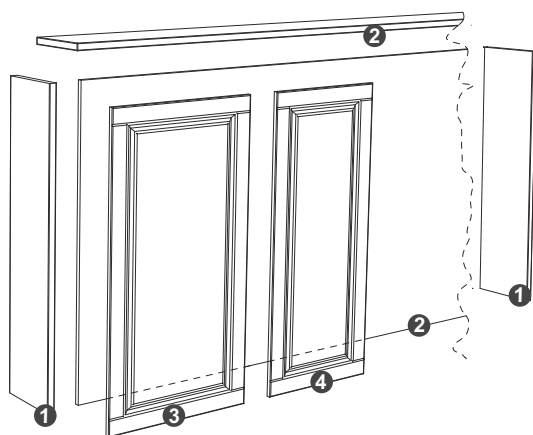

- ❶ Par bočnih stranica: 114x28x2,5 cm  
*Pair of sides: 114x28x2,5 cm*
- ❷ Radna ploča pulta: 38 mm (sa pripadajućim leđima)  
*Desk top panel: 38 mm (With their back)*
- ❸ Front: 40x101 cm / *Front: 40x101 cm*
- ❹ Front: 30x101 cm / *Front: 30x101 cm*

\* Dužina radne ploče definisana je Vašim izborom frontova.

\* *Length of worktop is defined by Your choice of fronts.*

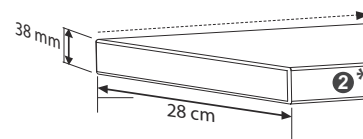



### Ručice Rustik

Ručice kod elemenata su izrađene od kombinacije drvo-metal sa kvalitetnom završnom obradom (nije farbana) tako da se ne može desiti da se ručica od upotrebe pohaba i izgrebe. Dimenzija ručica je 160 mm.

### Handle Rustic

The handle elements are made of combination of wood-metal with quality finish (not dyed) so that it can not happen that the lever of use frayed and scratched. The dimension of the handle is 160 mm.

### Italijanska vakuum tehnologija izrade frontova od medijapana

Vakuum presa nove generacija spada u savremenu tehnologiju završne obrade površina. Prednosti u odnosu na farbani MDF su ogromne jer je rezistentnost na habanje i udarce umnogome veća. Takođe se postižu idealno ravne i ujednačene površine što u kombinaciji sa kvalitetom koji pruža PVC folija rezultira dobrotom kombinacijom.

### Italian vacuum technology

New generation vacuum press is modern technology in surfaces final processing. Distinguished advantages of this technology compared to painted MDF are numerous, regarding its superb resistance to abrasion and impact. This technology provides final processing to perfectly smooth and even surface that, combined with PVC foil coating of high quality, results in the winning combination.

**MADE IN AUSTRIA**

# Titus+

Usporivači za sve frontove

*Slow motion for all front*

### Diht lajsna PVC

aida orah, san remo, aurora bianco, bež, arkosa pesak

### PVC upsand

aida walnut, san remo, aurora bianco, beige, sand arcossa

1, 2, 3, 4 m



### Završna lajsna - rustik belo

Finishing battens - rustic white

2,8 m



ID KZL43

### Podna lajsna PVC - bela, siva

Plinth - white, gray

2 m

3 m

4 m



ID 070922 - 2m + 2 ugaonika/corners  
 ID 071122 - 3m + 3 ugaonika/corners  
 ID 071022 - 4m + 4 ugaonika/corners  
 siva metalik  
 grey metallic

ID 070909 - 2m + 2 ugaonika/corners  
 ID 071109 - 3m + 3 ugaonika/corners  
 ID 071009 - 4m + 4 ugaonika/corners  
 bela  
 white

### Korpus / Corps



### Lice / Front



### Radna ploča / Worktop

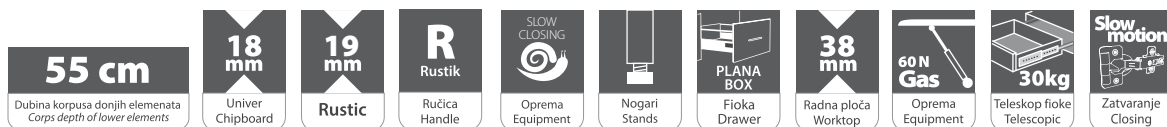



**RUSTIK V20**  
20 x 29 x 72 cm  
ID KV 2009



**RUSTIK V30**  
30 x 31 x 72 cm  
ID KV 3043

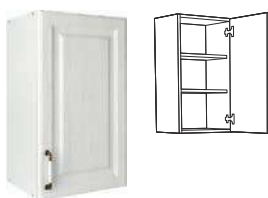

**RUSTIK V40**  
40 x 31 x 72 cm  
ID KV 4043

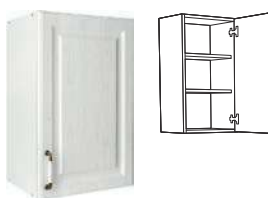

**RUSTIK V45**  
45 x 31 x 72 cm  
ID KV 4543



**RUSTIK VA50**  
50 x 31 x 57 cm  
ID KVA 5043



**RUSTIK V60**  
60 x 31 x 72 cm  
ID KV 6043



**RUSTIK VA60-68**  
60 x 31 x 68 cm  
ID KVA 606843



**RUSTIK VA60**  
60 x 31 x 57 cm  
ID KVA 6043

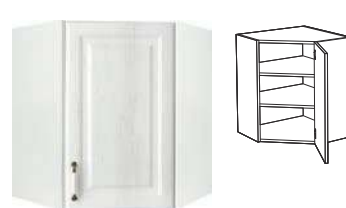

**RUSTIK VU60**  
60/31 x 60/31 x 72 cm  
ID KVV 6043



**RUSTIK VH60**  
60 x 31 x 72 cm  
ID KVH 6043



**RUSTIK VH80**  
80 x 31 x 72 cm  
ID KVH 8043



**RUSTIK VH60/36**  
60 x 31 x 36 cm  
ID KVH 603643



**RUSTIK VH80/36**  
80 x 31 x 36 cm  
ID KVH 803643

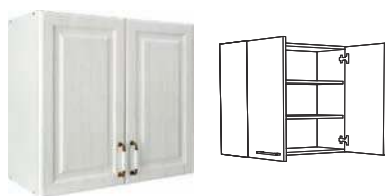

**RUSTIK V80**  
80 x 31 x 72 cm  
ID KV 8043



**RUSTIK V80 S**  
80 x 31 x 72 cm  
ID KV 80S43



**RUSTIK D60 RV**  
60 x 57 x 222 cm  
ID KD 60RV43



**RUSTIK FRIZ 60 / OSTAVA**  
RUSTIK FRIZ 60 / Fridge cabinet  
60 x 57 x 222 cm  
ID KFRIZ43

Dve police su uključene u cenu  
Two shelves are included in the price

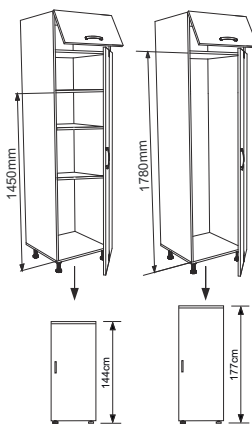

\* dimenzije frižidera \* fridge dimension



**RUSTIK FRIZ 2V**  
60 x 57 x 222 cm  
ID KFRIZ2V 43

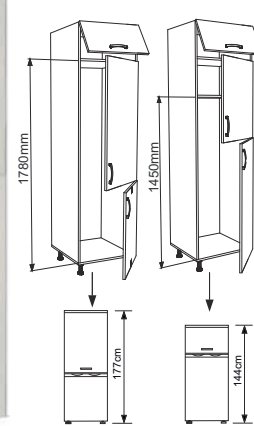

\* dimenzije frižidera \* fridge dimension

\* Svi elementi sa jednim krilom imaju mogućnost univerzalnog otvaranja \* All elements with one front have possibility of universal opening

Dimenzije su prikazane po principu širina x dubina x visina Dimensions are representing the principle of width by depth by height.





**RUSTIK D20 ŽICA**  
RUSTIK D20 pull out wire  
20 x 60 x 85 cm  
ID KD 2043



**RUSTIK D30**  
30 x 60 x 85 cm  
ID KD 3043



**RUSTIK D40 K**  
40 x 60 x 85 cm  
ID KD 40K43



**RUSTIK D40 F**  
40 x 60 x 85 cm  
ID KD 40F43



**RUSTIK D45 KF**  
45 x 60 x 85 cm  
ID KD 45KF43



**RUSTIK D60**  
60 x 60 x 85 cm  
ID KD 6043



**RUSTIK DU 2K**  
100 /60 x 100/60 x 85 cm  
ID KDU 2K43



**RUSTIK DU100**  
100 x 60 x 85 cm  
ID KDU 10043



**RUSTIK D80**  
80 x 60 x 85 cm  
ID KD 8043



**RUSTIK D80 S**  
80 x 60 x 82 cm  
ID KD 80S43

SUDOPERE SE  
POSEBNO NARUČUJU!  
*Sink are sold separately!*



**RUSTIK D40 F PL-BOX**  
40 x 60 x 85 cm  
ID KD 40FPLB43

**emuca**  
furniture fitting solutions  
METAL BOX  
SLOW MOTION



**RUSTIK D60 F PL-BOX**  
60 x 60 x 85 cm  
ID KD60FPLB43

**emuca**  
furniture fitting solutions  
METAL BOX  
SLOW MOTION



**RUSTIK D60 F**  
60 x 60 x 85 cm  
ID KD 60F43

TELESKOPSKI KLIZAČI  
*telescopic slides*



**RUSTIK D60 R**  
60 x 60 x 85 cm  
ID KD 60R43

FRONT MAŠINE ZA SUDOVE sa ručicom  
DISHWASHER PANEL with handle

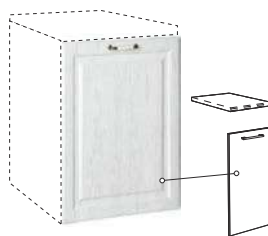

FRONT MAŠINE ZA SUDOVE  
DISHWASHER PANEL



FRONT MAŠINE ZA SUDOVE sa ručicom  
DISHWASHER PANEL with handle

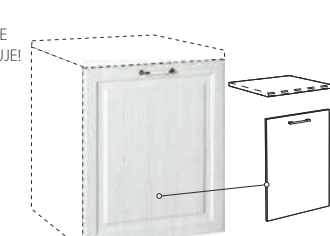

RADNA PLOČA SE  
POSEBNO NARUČUJE!  
*Worktop is an  
extra order!*

**RUSTIK MASKA 45 x 72**  
45 x 72 x 1,8 cm  
ID KMAS 457243

**RUSTIK MASKA 60 x 60**  
60 x 60 x 1,8 cm  
ID KMAS 606043

**RUSTIK MASKA 60 x 72**  
60 x 72 x 1,8 cm  
ID KMAS 607243



☆  
VISOKI SJAJ  
HIGH GLOSS

## KUHINJE IN MDF / KITCHEN IN MDF

Kuhinje IN MDF (od medijapana), takođe proizvedene na vakum presi, obložene PVC folijom nemačkog proizvođača, predstavljaju vrhunac u proizvodnji nameštaja. U odnosu na farbani medijapan kuhinje proizvedene na ovaj način odlikuju se većom otpornošću na habanje, udarce i grebanje.

U ponudi su najmoderniji dezeni u visokom sjaju. Svi korpusi IN MDF kuhinja su u beloj boji debljine 18 mm. Radne ploče su debljine 38 mm seku se na meru prema potrebama kupaca. U ponudi je rastući izbor dekora radnih ploča koji se savršeno uklapaju sa ponuđenim dezenima frontova. Ram za stakleno krilo je takođe od medijapana, urađen iz jednog komada, bez ikakvih spojeva i lepljenja. Ovakve kuhinje upotpunjene su metalnom ručicom, modernog dizajna, predstavljaju idealno rešenje za svaki dom.





*Kitchens IN MDF (MDF) produced in a vacuum press, PVC-coated foil, poses a peak in the manufacture of furniture. In relation to the painted MDF kitchen produced on Italian technology, German PVC laminate and MDF, are characterized by a higher resistance to abrasion, impact and scratching.*

*We offer modern designs in high gloss: white, beige, bordeaux, violet, ash gloss and aida cherry mat. All parts of the corpus IN MDF kitchen are white colored with thickness of 18 mm. Worktops are 38mm thick, cutted by customer wishes. There are 6 modern designs that fit perfectly with the offered designs of fronts. Frame for glass front is also made of MDF, made from a single piece, with no joints and glue. These kitchens complemented by an metal handle, modern designed are the ideal solution for every home.*





## KUHINJE IN MDF / KITCHEN IN MDF

Frontovi kuhinje IN MDF su izrađeni od medijapana (MDF-a, 19 mm). U godinama iza nas, MDF se izdvojio kao materijal koji u izradi kuhinjskih elemenata pokazuje brojne prednosti: povećana vodootpornost, otpornost na vodenu paru i lakoća obrade. Izborom Kuhinja IN MDF dobijate izuzetno kvalitetan kuhinjski nameštaj, a široka ponuda dezena je garant da ćete pronaći elemente koji će zadovoljiti Vaše želje.

*Kitchen IN MDF fronts are made of mediapan (MDF, 19 mm) PVC foil coated. In the years behind us, the MDF has distinguished itself as a material that produces numerous advantages in making of kitchens elements, even in comparison with the massive: increased waterproofing and water vapor resistance, easy processing, and much lower price. By choosing kitchen IN MDF You get high quality kitchen furniture and a wide range of patterns is guarantee that You will find elements that will satisfy Your aesthetic standards.*



Dobitnik nagrade za kvalitet u proizvodnji kuhinja!  
 The winner of the award for kitchen production quality!



Made in  
**Serbia**









**Titus**

**SLOW MOTION**  
Slow motion šarke  
Slow motion hinge



**PVC NOGARI**

Sve IN MDF kuhinje su postavljene na visinski podesive nogare.

*All IN MDF kitchens are put on PVC stands.*



Aluminijumske ručice  
Aluminium handle

**rujzdesign**  
handles  
MADE IN SLOVENIA

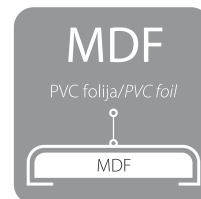

**MDF**

PVC folija/PVC foil

MDF

Frontovi od medijapana  
Fronts of MDF

Italijanska vakuum tehnologija.  
Italian vacuum technology.

**Diht lajsna PVC** aida orah, san remo, aurora bianco, bež, arkosa pesak  
**PVC upstand** aida walnut, san remo, arora bianco, beige, sand arcossa

**Završna lajsna** Jasen sjaj, belo sjaj, bež sjaj, bordo sjaj, violet sjaj,  
**Finishing battens** Ash gloss, white gloss, beige gloss, dark red gloss, violet gloss,

1, 2, 3, 4 m



2,8 m



**Podna lajsna PVC** bela, siva  
**Plinth** white, gray

2 m  
3 m  
4 m



bela  
white



siva metalik  
grey metallic

ID 070909 - 2m + 2 ugaonika/corners  
ID 071109 - 3m + 3 ugaonika/corners  
ID 071009 - 4m + 4 ugaonika/corners

ID 070922 - 2m + 2 ugaonika/corners  
ID 071122 - 3m + 3 ugaonika/corners  
ID 071022 - 4m + 4 ugaonika/corners

NAPOMENA: Kompletna šifra elementa se dobija zamenom zvezdica \*\* sa dve cifre iz prikazanih dezena.  
NOTE: The complete code of an element is obtained by replacing stars\*\* with two digits of the displayed pattern.

Korpus / Corps

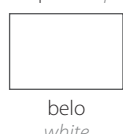

belo  
white



belo sjaj  
white gloss



bež sjaj  
beige gloss

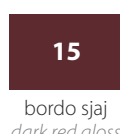

bordo sjaj  
dark red gloss



violet sjaj  
violet gloss



jasen sjaj  
ash gloss

Lice / Front

\*\*

Radna ploča / Worktop

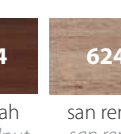
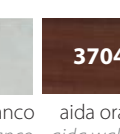
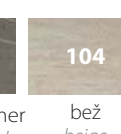

**55 cm**

Dubina korpusa donjih elemenata  
Corps depth of lower elements

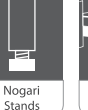



**IN MDF V20**  
20 x 29 x 72 cm  
ID KV 2009



**IN MDF V30**  
30 x 31 x 72 cm  
ID KV 30\*\*



**IN MDF V40**  
40 x 31 x 72 cm  
ID KV 40\*\*



**IN MDF V45**  
45 x 31 x 72 cm  
ID KV 45\*\*

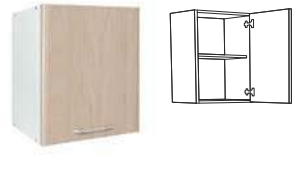

**IN MDF VA50**  
50 x 31 x 57 cm  
ID KVA 50\*\*



**IN MDF V60**  
60 x 31 x 72 cm  
ID KV 60\*\*

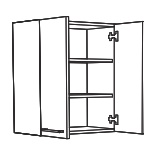

**IN MDF VA60-68**  
60 x 31 x 68 cm  
IDKVA 6068\*\*

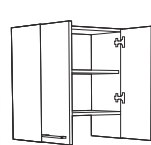

**IN MDF VA60**  
60 x 31 x 57 cm  
ID KVA 60\*\*

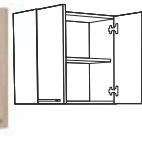

**IN MDF VU60**  
60/31 x 60/31 x 72 cm  
ID KVV 60\*\*



**IN MDF VH60**  
60 x 31 x 72 cm  
ID KVH 60\*\*

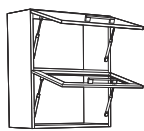

**IN MDF VH80**  
80 x 31 x 72 cm  
ID KVH 80\*\*

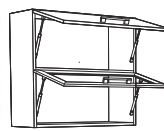

**IN MDF V80**  
80 x 31 x 72 cm  
ID KV 80\*\*

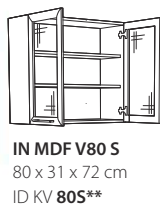

**IN MDF V80 S**  
80 x 31 x 72 cm  
ID KV 80S\*\*

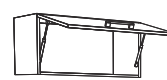

**IN MDF VH80/36**  
80 x 31 x 36 cm  
ID KVH 8036\*\*

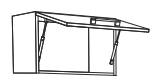

**IN MDF VH60/36**  
60 x 31 x 36 cm  
ID KVH 6036\*\*



**IN MDF D60 RV**  
60 x 57 x 222 cm  
ID KD 60RV\*\*



**RUSTIK FRIZ 60 / OSTAVA/Fridge cabinet**  
60 x 57 x 222 cm  
ID KFRIZ\*\*

↔ Dve police su uključene u cenu  
Two shelves are included in the price

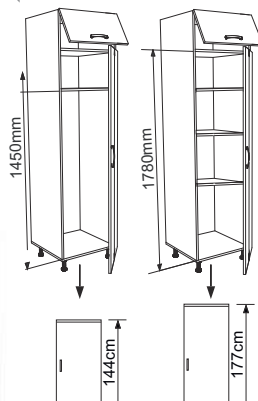

\* dimenzije frižidera \* fridge dimension



**IN MDF FRIZ 2V**  
60 x 57 x 222 cm  
ID KFRIZ2V\*\*

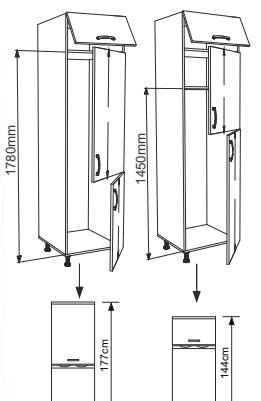

\* dimenzije frižidera \* fridge dimension

\* Svi elementi sa jednim krilom imaju mogućnost univerzalnog otvaranja. \* All elements with one front have possibility of universal opening.  
Dimenzije su prikazane po principu širina x dubina x visina. Dimensions are representing the principle of width by depth by height.



**IN MDF D20 ŽICA**  
IN MDF D20 pull out wire  
20 x 60 x 85 cm  
ID KD 20\*\*



**IN MDF D30**  
30 x 60 x 85 cm  
ID KD 30\*\*



**IN MDF D40 K**  
40 x 60 x 85 cm  
ID KD 40K\*\*



**IN MDF D40 F**  
40 x 60 x 85 cm  
ID KD 40F\*\*



**IN MDF D45 KF**  
45 x 60 x 85 cm  
ID KD 45KF\*\*



**IN MDF D60**  
60 x 60 x 85 cm  
ID KD 60\*\*



**IN MDF DU 2K**  
100 / 60 x 100 / 60 x 85 cm  
ID KDU 2K\*\*

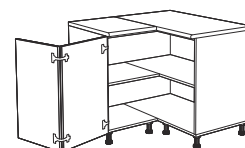

**IN MDF DU100**  
100 x 60 x 85 cm  
ID KDU 100\*\*



**IN MDF D80**  
80 x 60 x 85 cm  
ID KD 80\*\*



**IN MDF D80 S**  
80 x 60 x 82 cm  
ID KD 80S\*\*

SUDOPERE SE  
POSEBNO NARUČUJU!  
*Sink are sold separately!*



**IN MDF D40 F PL-BOX**  
40 x 60 x 85 cm  
ID KD 40FPLB\*\*



**IN MDF D60 F PL-BOX**  
60 x 60 x 85 cm  
ID KD 60FPLB\*\*



**IN MDF D60 F**  
60 x 60 x 85 cm  
ID KD 60F\*\*

TELESKOPSKI KLIZAČI  
*telescopic slides*



**IN MDF D60 R**  
60 x 60 x 85 cm  
ID KD 60R\*\*

FRONT MAŠINE ZA SUDOVE sa ručicom  
DISHWASHER PANEL with handle

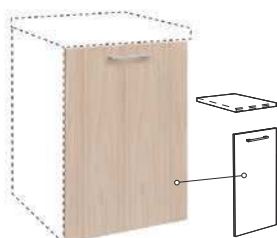

**IN MDF MASKA 45 x 72**  
45 x 72 x 1,8 cm  
ID KMAS 4572\*\*

FRONT MAŠINE ZA SUDOVE  
DISHWASHER PANEL



**IN MDF MASKA 60 x 60**  
60 x 60 x 1,8 cm  
ID KMAS 6060\*\*

RADNA PLOČA SE  
POSEBNO NARUČUJE!  
*Worktop is an  
extra order!*

FRONT MAŠINE ZA SUDOVE sa ručicom  
DISHWASHER PANEL with handle



**IN MDF MASKA 60 x 72**  
60 x 72 x 1,8 cm  
ID KMAS 6072\*\*

NAPOMENA: Kompletna šifra elementa se dobija zamenom zvezdica \*\* sa dve cifre iz prikazanih dezena.  
*NOTE: The complete code of an element is obtained by replacing stars\*\* with two digits of the displayed pattern.*





## KUHINJE IN / KITCHEN IN

Dekori u trendu i funkcionalnost elemenata osnovne su karakteristike kuhinje IN. Elementi na PVC nogarima omogućavaju bolju zaštitu i lakše održavanje kuhinje. Dubina korpusa je sada 55cm, donji elementi su na visinski podesivim PVC nogarima sa zatvorenom PVC soklom koja se lako skida i održava čistom. Ručice su metalne potpuno novog dizajna. Frontovi su okantovani sa sve 4 strane ABS 1 mm.

*Trendy decor and functionality of elements are basic features of the IN kitchen. Elements with the plastic legs provide better protection and easier maintenance of the kitchen. The corps depth is now 55 cm, number of elements is expanded to 33, standing elements are now on PVC stands with PVC plinths. Handles are made of metal and have completely new design. The fronts with edge on all 4 sides ABS 1 mm.*



Made in  
**Serbia**





## KUHINJE IN / KITCHEN IN

---

Ono što karakteriše MATIS IN kuhinje i izdvaja ih od ostalih je odabir materijala od kojih su izrađene. MATIS IN kuhinje izrađene su od oplemenjenog univera debljine 18mm renomiranih svetskih proizvođača Egger i Kronospan, dok je debljina radne ploče 28 mm.

*What characterizes MATIS IN kitchens and segregates them from the rest is selection of the materials they are made of. MATIS IN kitchens are made of 18 mm thick refined chipboard from renowned manufacturers Egger and Kronospan, with worktop thickness of 28 mm.*











Ručice IN  
Handle IN



Usporivači za sve frontove  
Slow motion for all fronts



Radna ploča 28 mm  
Worktop 28 mm



**PVC NOGARI**  
Sve IN MDF kuhinje su  
visinski podesive PVC nogare.  
All IN MDF kitchens  
are put on PVC stands.

rd ruzdesign  
handles

MADE IN AUSTRIA  
**Titus**

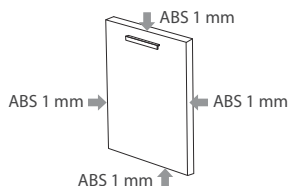

FRONTOVI KANTOVANI SA 4 STRANE  
18 mm univer, sa ABS-om 1 mm.  
Four side edge banding of front doors  
18 mm chipboard, with ABS 1 mm.

**Završna lajsna**  
sivi hrast, snežni hrast  
*Finishing battens*  
gray oak, snow oak

2,8 m



**Diht lajsna PVC**  
aurora bianco, arkosa pesak, siva, bež  
*PVC upstand*  
aurora bianco, sand arcossa, gray, beige

1, 2, 3, 4 m



**Podna lajsna PVC**  
bela, siva  
*Plinth*  
white, gray

2 m  
3 m  
4 m

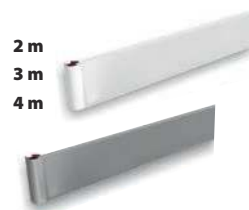

ID 070909 - 2m + 2 ugaonika/corners  
 ID 071109 - 3m + 3 ugaonika/corners  
 ID 071009 - 4m + 4 ugaonika/corners  
 bela  
white  
 ID 070922 - 2m + 2 ugaonika/corners  
 ID 071122 - 3m + 3 ugaonika/corners  
 ID 071022 - 4m + 4 ugaonika/corners  
 siva metalik  
gray metallic

NAPOMENA: Kompletna šifra elementa se dobija zamenom zvezdica \*\* sa dve cifre iz prikazanih dezena.  
NOTE: The complete code of an element is obtained by replacing stars\*\* with two digits of the displayed pattern.



**55 cm**  
Dubina korpasa donjih elemenata  
Corps depth of lower elements

**18 mm**  
Univer  
Chipboard

**28 mm**  
Radna ploča  
Worktop

**M**  
Metal  
Ručica  
Handle

**ABS**  
**1 mm**  
Kant traka  
Edge Band

**Nogari**  
Stands

**Slow motion**  
Zatvaranje  
Closing

**60 N Gas**  
Oprema  
Equipment

**30kg**  
Teleskop fioke  
Telescopic

**SLOW CLOSING**  
Oprema  
Equipment



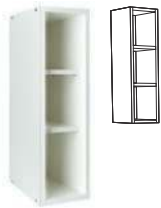

**IN V20**  
20 x 29 x 72 cm  
ID KV 2009

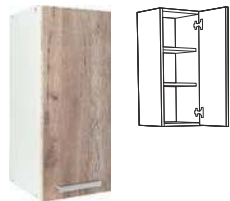

**IN V30**  
30 x 31 x 72 cm  
ID KV 30\*\*



**IN V40**  
40 x 31 x 72 cm  
ID KV 40\*\*



**IN V45**  
45 x 31 x 72 cm  
ID KV 45\*\*



**IN VA50**  
50 x 31 x 57 cm  
ID KVA 50\*\*



**IN V60**  
60 x 31 x 72 cm  
ID KV 60\*\*



**IN VA60-68**  
60 x 31 x 68 cm  
ID KVA 6068\*\*



**IN VA60**  
60 x 31 x 57 cm  
ID KVA 60\*\*

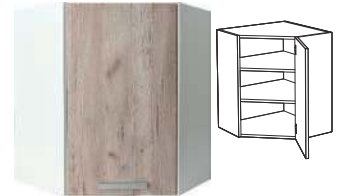

**IN VU60**  
60/31 x 60/31 x 72 cm  
ID KVV 60\*\*



**IN VH60**  
60 x 31 x 72 cm  
ID KVH 60\*\*



**IN VH80**  
80 x 31 x 72 cm  
ID KVH 80\*\*



**IN VH80/36**  
80 x 31 x 36 cm  
ID KVH 8036\*\*



**IN VH60/36**  
60 x 31 x 36 cm  
ID KVH 6036\*\*



**IN V80**  
80 x 31 x 72 cm  
ID KV 80\*\*



**IN V80 S**  
80 x 31 x 72 cm  
ID KV 80S\*\*



**IN D60 RV**  
60 x 57 x 222 cm  
ID KD 60RV\*\*



**IN FRIZ 60 / OSTAVA**  
60 x 57 x 222 cm  
ID KFRIZ\*\*

↔ Dve police su uključene u cenu  
Two shelves are included in the price

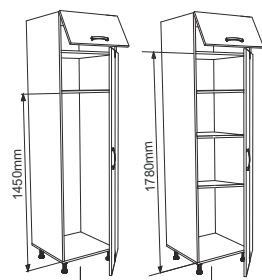

1450mm  
1780mm  
144cm  
177cm  
\* dimenzije frižidera \* fridge dimension



**IN FRIZ 2V**  
60 x 57 x 222 cm  
ID KFRIZ2V\*\*

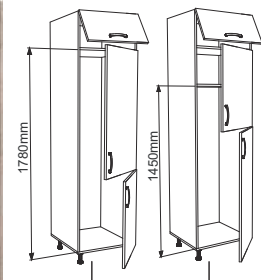

1780mm  
1450mm  
177cm  
144cm  
\* dimenzije frižidera \* fridge dimension

\* Svi elementi sa jednim krilom imaju mogućnost univerzalnog otvaranja \* All elements with one front have possibility of universal opening  
Dimenzije su prikazane po principu širina x dubina x visina. Dimensions are representing the principle of width by depth by height.



**IN D20 ŽICA**  
IN D20 pull out wire  
20 x 60 x 85 cm  
ID KD 20\*\*



**IN D30**  
30 x 60 x 85 cm  
ID KD 30\*\*



**IN D40 K**  
40 x 60 x 85 cm  
ID KD 40K\*\*



**IN D40 F**  
40 x 60 x 85 cm  
ID KD 40F\*\*



**IN D45 KF**  
45 x 60 x 85 cm  
ID KD 45KF\*\*



**IN D60**  
60 x 60 x 85 cm  
ID KD 60\*\*



**IN DU 2K**  
100 / 60 x 100 / 60 x 85 cm  
ID KDU 2K\*\*



**IN DU100**  
100 x 60 x 85 cm  
ID KDU 100\*\*



**IN D80**  
80 x 60 x 85 cm  
ID KD 80\*\*



**IN D80 S**  
80 x 60 x 82 cm  
ID KD 80S\*\*

SUDOPERE SE  
POSEBNO NARUČUJU!  
*Sink are sold separately!*



**IN D60 F**  
60 x 60 x 85 cm  
ID KD 60F\*\*

TELESKOPSKI KLIZAČI  
*telescopic slides*



**IN D60 R**  
60 x 60 x 85 cm  
ID KD 60R\*\*

FRONT MAŠINE ZA SUDOVE sa ručicom  
DISHWASHER PANEL with handle

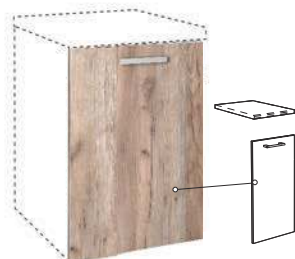

**IN MASKA 45 x 72**  
45 x 72 x 1,8 cm  
ID KMAS 4572\*\*

FRONT MAŠINE ZA SUDOVE  
DISHWASHER PANEL

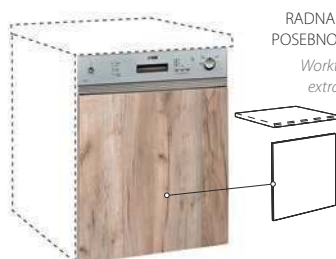

**IN MASKA 60 x 60**  
60 x 60 x 1,8 cm  
ID KMAS 6060\*\*

RADNA PLOČA SE  
POSEBNO NARUČUJE!  
*Worktop is an  
extra order!*

FRONT MAŠINE ZA SUDOVE sa ručicom  
DISHWASHER PANEL with handle

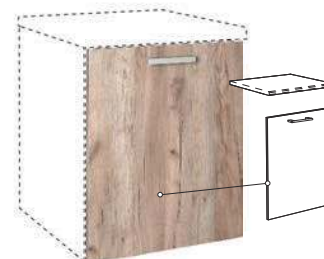

**IN MASKA 60 x 72**  
60 x 72 x 1,8 cm  
ID KMAS 6072\*\*

NAPOMENA: Kompletna šifra elementa se dobija zamenom zvezdica \*\* sa dve cifre iz prikazanih dezena.  
NOTE: The complete code of an element is obtained by replacing stars\*\* with two digits of the displayed pattern.





2. V60A ID 036046

Opcioni element  
Optional element



1. Snežni hrast/Snow oak  
ID 031546

## BLOK KUHINJE/BLOCK KITCHENS 200

Blok kuhinje predstavljaju optimalnu kombinaciju donjih i gornjih kuhinjskih elemenata u odnosu na datu površinu. Kupovinom Blok kuhinja, dobijate konfiguraciju koja sadrži sve osnovne kuhinjske elemente neophodne prosečnom korisniku. Osim po praktičnosti, Blok kuhinje kompanije Matis izdvajaju se i po veoma pristupačnoj ceni.

*Kitchen block represents optimal combination of the lower and upper kitchen elements in relation to the given surface. By purchasing Kitchen block you get a configuration that contains all the basic kitchen elements necessary for the average use. Except for practical use, Matis Kitchen Blocks are also available at a very affordable price.*



**V40**

40 x 30 x 66 cm

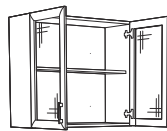

**V80 S**

80 x 30 x 66 cm

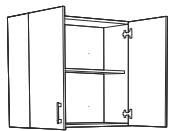

**V80**

80 x 30 x 66 cm

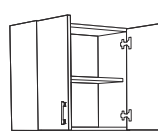

**V60A**

60 x 31 x 57 cm

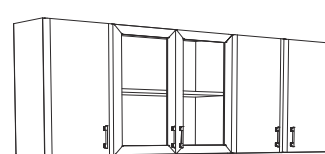

200 x 60 x 216 cm



**D40 F**

40 x 60 x 85 cm

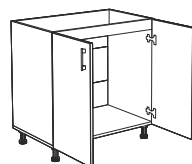

**D80 S**

80 x 47 x 82 cm

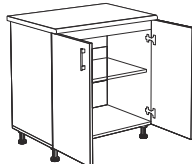

**D80**

80 x 60 x 82 cm

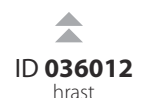

**ID 036012**  
hrast

**ID 036046**  
snežni hrast

Opcioni element  
Optional element

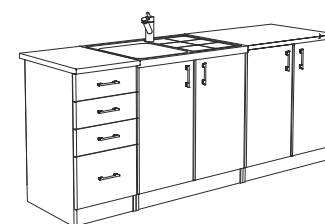



PVC NOGARI

Hrast/Oak  
ID 031512

Univer sokla/Chipboard plinth

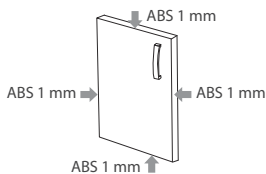

18 mm univer, sa ABS-om 1mm.  
18 mm chipboard, with ABS 1mm.

FRONTOVI KANTOVANI SA 4 STRANE  
Four side edge banding of front doors



PVC NOGARI

Za lakše održavanje i bolju zaštitu  
For better maintenance and protection



Metalne ručice  
Metal handle

**2 m**

Završna lajsna je uključena u cenu.  
Finishing batten is included in price.

Završna lajsna - hrast, snežni hrast  
Finishing battens - oak, snow oak



**2 m**

Podna lajsna - sokla je uključena u cenu.  
Plinth is included in price.

Podna lajsna-sokla-bela univer  
Plinth - white chipboard



Sudopera i diht lajsna se dodatno naručuju./Kitchen sinks and PVC upstands are ordered separately.

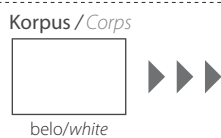

**45 cm**

Dubina korpusa donjih elemenata  
Corps depth of lower elements

**18 mm**

Univer  
Chipboard

**28 mm**

Radna ploča  
Worktop



**ABS**  
**1 mm**

Kant traka  
Edge Band

**M**  
**Metal**

Ručica  
Handle



## SUDOPERE/KITCHEN SINKS

**Metalac**



**C480F1M1**

Usadna sudopera okrugla  
Inset rounded sink  
Ø 480 mm • ID **070401**

**Metalac**



**1D770435FP**

Usadna sudopera univerzalna  
Inset universal sink  
770 x 435 mm • ID **070900**

**Alveus**



**FORM 10**

Usadna sudopera okrugla  
Inset rounded sink  
Ø 450 mm • ID **070903**

**Alveus**



**BASIC 150**

Usadna sudopera univerzalna  
Inset universal sink  
780 x 435 mm • ID **070905**

**Metalac**



**C480F1M1 B**

Usadna sudopera okrugla  
sa rupom za slavinu  
Rounded sink with faucet hole  
Ø 480 mm • ID **070501**

**Metalac**



Nasadna sudopera - leva i desna  
Undermount sink - left and right  
ID **070101** - DESNA / right  
ID **070201** - LEVA / left

**Alveus**



**FORM 30**

Usadna sudopera okrugla  
sa rupom za slavinu  
Rounded sink with faucet hole  
Ø 510 mm • ID **070904**

**Alveus**



**CLASSIC 30**

Nasadna sudopera leva i desna  
Undermount sink - left and right  
ID **070100** - DESNA / right  
ID **070200** - LEVA / left

**Metalac**



**1D465435FP1**

Usadna sudopera kockica  
Inset square sink  
465 x 435mm • ID **070901**

**Metalac**



Nasadna sudopera 2D  
Undermount sink 2D  
ID **070301**

**Alveus**



**BASIC 10**

Usadna sudopera kockica  
Inset square sink  
380 x 440 mm • ID **070906**

**Alveus**



**CLASSIC 40**

Nasadna sudopera dvodelna  
Undermount sink  
ID **070300**

**Metalac**



**GRANITNA SUDOPERA  
XVENERA**

Dubina korita 180mm  
Dodatak uz sudoperu sifon φ 90 mm  
Ø 510 mm • ID **MGVEN3**  
bela, crna, siva, bež, šampanj

**Metalac**



**GRANITNA SUDOPERA  
XQUADRO M**

Dubina korita 190mm  
Dodatak uz sudoperu sifon φ 90 mm  
620 x 500 mm • ID **MGQUAM1**  
bela, crna, siva, bež, šampanj

**Metalac**



**GRANITNA SUDOPERA  
XQUADRO 40**

Dubina korita 210 mm  
Dodatak uz sudoperu sifon φ 90 mm  
500 x 400 mm • ID **MGQUA402**  
bela, crna, siva, bež, šampanj

**Metalac**



**GRANITNA SUDOPERA  
XQUADRO PLUS**

Dubina korita 190 mm  
Dodatak uz sudoperu sifon φ 90 mm  
770 x 500 mm • ID **MGQUA+1**  
bela, crna, siva, bež, šampanj





## DODACI/ACCESSORIES

### Završne lajsne IN MDF 2,8 m

Finishing battens IN MDF 2,8 m

jasen sjaj / ID KZL53  
ash gloss

belo sjaj / ID KZL14  
white gloss

bež sjaj / ID KZL33  
beige gloss

bordo sjaj / ID KZL15  
dark red gloss

violet sjaj / ID KZL32  
violet gloss

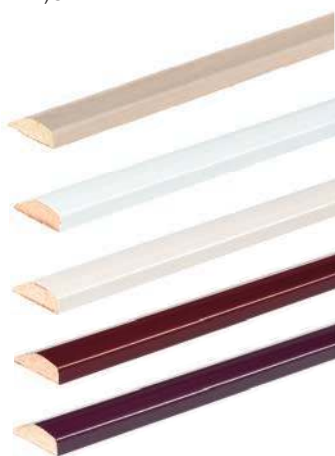

### PVC Diht lajsne 1, 2, 3, 4 m

PVC Upstands 1, 2, 3, 4 m

#### ELEGANCE LINE

IN MDF pietra mermer ID KDLK024

RUSTIK pietra marbel

IN MDF aida orah ID KDL3704

aida walnut

IN MDF / IN san remo / san remo ID KDL624

IN MDF / IN aurora bianco ID KDL166

aurora bianco

IN MDF / IN bež / beige ID KDL104

IN MDF / IN arkosa pesak ID KDL276

sand arcossa



### Završne lajsne IN 2,8 m

Finishing battens IN 2,8 m

sivi hrast ID KZL44  
gray oak

snežni hrast ID KZL46  
snow oak



### Podne PVC lajsne - sokle

Plinths PVC

Podne lajsne za kuhinje  
bela, siva

Kitchen floor plinths  
white, grey

ID 070909 - 2m + 2 ugaonika/corners  
 ID 071109 - 3m + 3 ugaonika/corners  
 ID 071009 - 4m + 4 ugaonika/corners  
 bela  
white

ID 070922 - 2m + 2 ugaonika/corners  
 ID 071122 - 3m + 3 ugaonika/corners  
 ID 071022 - 4m + 4 ugaonika/corners  
 siva metalik  
grey metallic

### Završne lajsne Rustik 2,8 m

Finishing battens Rustic 2,8 m

rustik belo ID KZL43  
rustic white



2 m

3 m

4 m





## TRPEZARIJSKI STO RUSTIK / *DINNING TABLE RUSTIC* dimenzija/dimension: 120 x 80 x 75,5 cm

Trpezarijski stolovi su centralni komad nameštaja u svakoj trpezariji. Izbor trpezarijskog stola uslovljava dizajn sitnijih komada trpezarijskog nameštaja, zbog čega je jako bitno da budete sigurni u njegovu stabilnost i postojanost tokom dugog niza godina. U Matis salonima nameštaja možete pronaći trpezarijske stolove svih oblika, dimenzija i dezena i sigurni smo da se u našoj ponudi krije jedan kao stvoren za Vas.

*Dining tables are a central piece of furniture in every dining room. The choice of dining table requires design of smaller pieces of dining furniture, because it is very important to be sure of its stability and consistency over many years. In Matis Furniture Showrooms you can find dining tables of all shapes, sizes and designs and we are sure that in our offer there is the one that is created for you.*



MDF ploča 19 mm, presvučena folijom  
MDF panel 19 mm, coated with foil

Nogari i podkonstrukcija od drveta  
Legs and substructure of wood

ID 080538  
Belo / Aida orah  
White / Aida walnut

# Matis Wood



Belo / Aida orah  
White / Aida walnut

Made in  
**Serbia**



# TRPEZARIJSKI STO ML / DINNING TABLE ML

## ML 7

dimenzija/dimension: 100/140 x 100 x 77 cm



## ML 8 PLUS

dimenzija/dimension: 144/181 x 103 x 77 cm



**ID MITA151**  
Belo/White

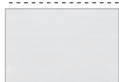

Belo  
White

**ID MITA153**  
Wenge



Wenge  
Wenge

**ID MITA152**  
Belo/White

**ID MITA158**  
Wenge



Čistota odgovornog šumarstva

# TRPEZARIJSKI STO MISTIK / DINNING TABLE MISTIK

## MISTIK I

dimenzija/dimension: 160 x 90 x 75 cm

Sto napravljen od drveta bukve.



## MISTIK II

dimenzija/dimension: 120 x 80 x 75 cm

Sto napravljen od drveta bukve.



**ID FIS003**  
Bukva/Beech

**ID FIS013**  
Hrast/Oak

**ID FIS030**  
Wenge/Wenge



Bukva  
Beech



Hrast  
Oak



Wenge  
Wenge

**ID FIS004**  
Bukva/Beech

**ID FIS014**  
Hrast/Oak

**ID FIS021**  
Wenge/Wenge



Čistota odgovornog šumarstva



## TRPEZARIJSKE STOLICE DRINA/*DINNING CHAIRS DRINA* dimenzija/dimension: 43.5 x 49 x 94.5 cm



ID **BBS581**  
belo/verona 38 zeleno  
*white/verona 38 green*



ID **BBS589**  
belo/verona 757 tirkiz  
*white/verona 757 tirkiz*



ID **BBS587**  
belo/verona 64 braon  
*white/verona 64 brown*



ID **BBS587**  
belo/verona 736 sivo  
*white/verona 736 grey*



ID **BBS579**  
tamni hrast/verona 24 bež  
*dark oak/verona 24 beige*

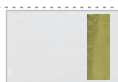

Belo/Verona 38 zeleno  
*White/Verona 38 green*

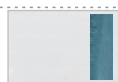

Belo/Verona 757 tirkiz  
*White/Verona 757 tirkiz*

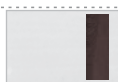

Belo/Verona 64 braon  
*White/Verona 64 brown*



Belo/Verona 736 sivo  
*White/Verona 736 grey*



Tamni hrast/Verona 24 bež  
*Dark oak/Verona 24 beige*

## TRPEZARIJSKE STOLICE S5/*DINNING CHAIRS S5*

dimenzija/dimension: 40 x 46.5 x 103 cm



ID **BBS577**  
tamni hrast/verona 38 zeleno  
*dark oak/verona 38 green*



ID **BBS576**  
belo/verona 757 tirkiz  
*white/verona 757 tirkiz*



ID **BBS575**  
belo/verona 736 sivo  
*white/verona 736 grey*



ID **BBS574**  
tamni hrast/verona 24 bež  
*dark oak/verona 24 beige*

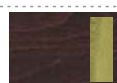

Tamni hrast/Verona 38 zeleno  
*Dark oak/Verona 38 green*

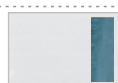

Belo/Verona 757 tirkiz  
*White/Verona 757 tirkiz*



Belo/Verona 736 sivo  
*White/Verona 736 grey*



Tamni hrast/Verona 24 bež  
*Dark oak/Verona 24 beige*

## TRPEZARIJSKE STOLICE PALMA/*DINNING CHAIRS PALMA* dimenzija/dimension: 48 x 48 x 100 cm



ID **PR73092**  
Palma natur/malteze  
*Palma natur/malteze*



ID **PR73093**  
Palma trešnja/malteze  
*Palma cherry/malteze*



ID **PR73072**  
Palma wenge/malteze  
*Palma wenge/malteze*



ID **PR73071**  
Palma natur/bež  
*Palma natur/beige*



ID **PR73091**  
Palma trešnja/bež  
*Palma cherry/beige*



ID **PR73090**  
Palma wenge/bež  
*Palma wenge/beige*

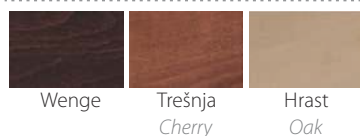

Wenge

Trešnja  
*Cherry*

Hrast  
*Oak*

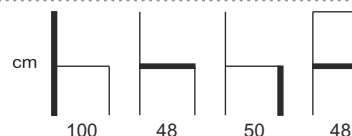

cm

100

48

50

48



Materijal  
Material

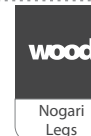

Nogari  
Legs

## TRPEZARIJSKE STOLICE JELENA

### DINNING CHAIRS JELENA

dimenzija/dimension: 47 x 47 x 105 cm



**ID MITA169**  
**STOLICA JELENA**  
belo/verona 66 sivo  
white/verona 66 grey



**ID MITA170**  
**STOLICA JELENA**  
hrast/verona 64  
oak/verona 64



**ID MITA168**  
**STOLICA JELENA**  
wenge/verona 24  
wenge/verona 24

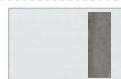

Belo/Verona 736 sivo  
White/Verona 736 grey



Hrast/Verona 24 bež  
Oak/Verona 24 beige



Wenge/Verona 24 bež  
Wenge/Verona 24 beige

## TRPEZARIJSKE STOLICE GARDEL

### DINNING CHAIRS GARDEL

dimenzija/dimension: 42 x 49 x 92 cm



**ID FIS022**  
bela/capry1009 siva  
white/capry1009 gray



**ID FIS025**  
hrast/capry1003 bež  
oak/capry1003 beige



**ID FIS006**  
wenge/capry1003 bež  
wenge/capry1003 beige

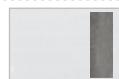

bela/capry1009 siva  
white/capry1009 gray

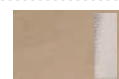

hrast/capry1003 bež  
oak/capry1003 beige



wenge/capry1003 bež  
wenge/capry1003 beige

## TRPEZARIJSKE STOLICE INES/DINNING CHAIRS INES

dimenzija/dimension: 45 x 44 x 97 cm



**ID FIS121**  
bela/capry1009 siva  
white/capry1009 gray



**ID FIS119**  
bukva/capry1003 bež  
beech/capry1003 beige



**ID FIS122**  
hrast/capry1009 siva  
oak/capry1009 gray



**ID FIS120**  
wenge/capry1003 bež  
wenge/capry1003 beige

## TRPEZARIJSKE STOLICE LEO/DINNING CHAIRS LEO

dimenzija/dimension: 43 x 47 x 97 cm



**ID FIS118**  
bela/capry1009 siva  
white/capry1009 gray



**ID FIS116**  
bukva/capry1003 bež  
beech/capry1003 beige



**ID FIS123**  
hrast/capry1009 siva  
oak/capry1009 gray



**ID FIS117**  
wenge/capry1003 bež  
wenge/capry1003 beige

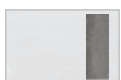

Bela/Capry1009 siva  
White/Capry1009 gray



bukva/Capry1003 bež  
Beech/Capry1003 beige



Hrast/Capry1003 bež  
Oak/Capry1003 beige



Wenge/Capry1003 bež  
Wenge/Capry1003 beige



## PREDSOBLJE RUSTIK

### HALL UNIT RUSTIC

Za ljubitelje klasične lepote i vanvremenskih dizajnerskih formi proširili smo Rustik kolekciju nameštaja. Znate nas već po nagrađivanim i dokazano kvalitetnim Rustik kuhinjama, koje su osvojile srca i i украсile mnoge domove naših vernih kupaca. Sada Vam predstavljamo novo Rustik predsoblje. Sačinjeno je od pet elemenata i projektovano tako da podržava i ispunjava sve neophodne funkcije nameštaja za predsoblje. Svuda su većinski postavljene police pomerljive po visini, kako bi se lagodno skladištila obuća svih gabarita. Frontovi i vertikalne dekorativne lajsne su načinjeni od medijapana presvučenog rustik folijom na italijanskoj vakuum presi, sa izuzetkom dekorativne rustik lajsne ispod plafona koja se izrađuje od drveta.

*For all lovers of classical beauty and timeless design forms, we have expanded our Rustik collection. You may be already familiar with our awarded and proven quality Rustik kitchens, that won the hearts and decorated many homes of our loyal customers.*

*Now we are presenting our new Rustik hall units. Composed of five elements and designed in order to support and provide all necessary functions of hall furniture items. Each item has shelves adjustable in height, with capacity for stacking of different sizes footwear. Fronts and vertical decorative battens are made of MDF, coated with rustik foil on italian vacuum press, with an exception of decorative rustik batten under the ceiling that is made of wood.*





**Rustik ormar**  
*Rustik wardrobe*  
66,5x209x40,6cm  
ID 620543

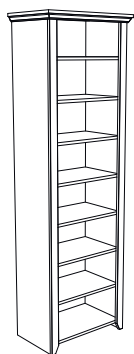

**Rustik ogledalo**  
*Rustik mirror*  
75x98x2cm  
ID 620443

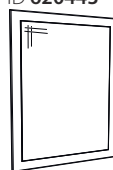

**Rustik cipelar**  
*Rustik shoe cabinet*  
75x98x40,6cm  
ID 620143



**Rustik čiviluk**  
*Rustik hanger*  
75x133x5cm  
ID 620243

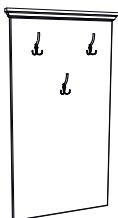

**Rustik komoda sa jastučicom**  
*Rustik cupboard with pillow*  
75x54x40,6cm  
ID 620343



rustik belo  
*rustic white*





## MDF PREDSOBLJA / MDF HALL UNITS

Funkcionalna, jednostavna za montažu, sa frontovima izrađenim od medijapana (MDF). Pojedinačni, međusobno kompatibilni elementi, izrađeni u više dekora, omogućavaju veliki broj kombinacija za uređenje Vašeg doma. Izaberite kombinaciju elemenata sa odgovarajućim cipelarima i komodama i učinite prijatnom dobrodošlicu u Vaš dom.

*Functional, easy to install, with fronts made of MDF. Individual, mutually compatible elements, made in several patterns, allow a large number of combinations to decorate your home. Choose a combination of elements with appropriate shoe cabinets and chests and make a warm welcome to Your home.*



Made in  
**Serbia**



# MDF PREDOBLJA / MDF UNITS

frontovi od medijapana / fronts of MDF

## Apolon PA 1 MDF

50x37x209 cm

ID 100133

Hrast/bež sjaj  
Oak/beige gloss

ID 102114

Tobako/belo sjaj  
Tobacco/white gloss



## Apolon PA 1 O MDF

50x37x209 cm

ID 101033

Hrast/bež sjaj  
Oak/beige gloss

ID 102214

Tobako/belo sjaj  
Tobacco/white gloss

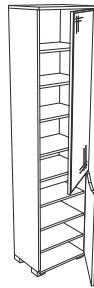

## Apolon PA 2 MDF

50x37x209 cm

ID 100233

Hrast/bež sjaj  
Oak/beige gloss

ID 102314

Tobako/belo sjaj  
Tobacco/white gloss

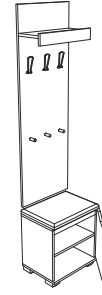

## Apolon PA 3 MDF

50x113 cm - ogledalo/mirror

ID 100433

Hrast/bež sjaj  
Oak/beige gloss

ID 100402

Tobako/belo sjaj  
Tobacco/white gloss



## Apolon PA 5 MDF

50x22x114 cm

ID 100833

Hrast/bež sjaj  
Oak/beige gloss

ID 102514

Tobako/belo sjaj  
Tobacco/white gloss

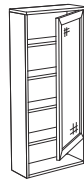

PODOVI I PLAFONI OKANTOVANI SA TRI STRANE!  
TREE SIDE EDGE BANDING OF FLOORS AND CEILING!

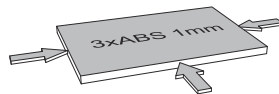

## Apolon PA 6 MDF

25x37x209 cm

ID 100933

Hrast/bež sjaj  
Oak/beige gloss

ID 102614

Tobako/belo sjaj  
Tobacco/white gloss

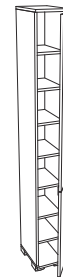

## Apolon PA-3

50x37x95 cm - komoda/cupboard

ID 100333

Hrast/bež sjaj  
Oak/beige gloss

ID 102414

Tobako/belo sjaj  
Tobacco/white gloss



NAPOMENA: Sva vrata su pripremljena za levo i desno otvaranje. NOTE: All doors are ready for left and right opening.

# MDF CIPELARI / MDF SHOE CABINETS

## Cipelar "Odisej 3V MDF"

70 x 28 x 120 cm

Shoe cabinets "Odyssey 3V MDF"

ID 130214

tobako-belo sjaj  
tobacco-white gloss

ID 130233

hrast-bež sjaj/  
oak-beige gloss

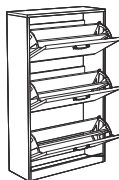

## Cipelar "Odisej 4V"

70 x 28 x 157 cm

Shoe cabinets "Odyssey 4V MDF"

ID 130314

tobako-belo sjaj  
tobacco-white gloss

ID 130333

hrast-bež sjaj/  
oak-beige gloss



Hrast/bež sjaj  
Oak/Beige gloss



Tobako/belo sjaj  
Tobacco/white gloss

rd ruzjdesign  
handles  
MADE IN SLOVENIA

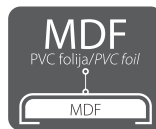





# APOLON

frontovi od univera-softforming obrada / fronts of chipboard-softforming

## Apolon PA 5

50 x 22 x 114 cm

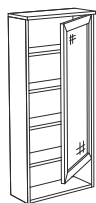

ID 100809  
belo/white



ID 100803  
trešnja/cherry



ID 100812  
hrast/oak



ID 100846  
snežni hrast/snow oak



ID 100852  
tobako/tobacco

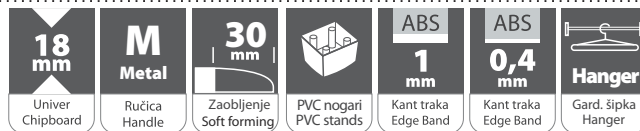
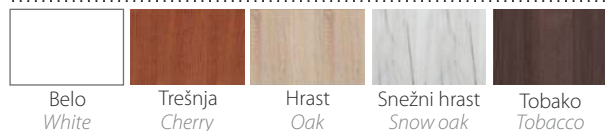

**Apolon PA 1**  
50 x 37 x 209 cm

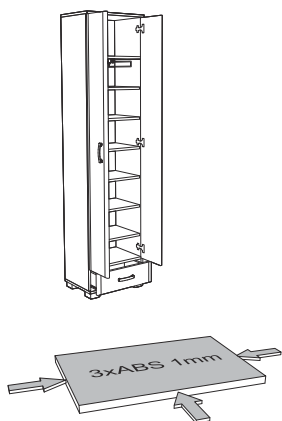

ID 100109  
belo / white

ID 100103  
trešnja / cherry

ID 100112  
hrast / oak

ID 100146  
snežni hrast / snow oak

ID 100152  
tobako / tobacco

**Apolon PA 2**  
50 x 37 x 209 cm

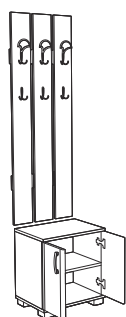

ID 100209  
belo / white

ID 100203  
trešnja / cherry

ID 100212  
hrast / oak

ID 100246  
snežni hrast / snow oak

ID 100252  
tobako / tobacco

**Apolon PA 3  
Ogledalo**

Apolon PA 3 mirror  
50 x 113 cm



ID 100409  
belo / white  
MDF

ID 100403  
trešnja / cherry  
MDF

ID 100412  
hrast / oak  
MDF

ID 100446  
snežni hrast / snow oak  
MDF

ID 100452  
tobako / tobacco  
MDF

**Apolon  
PA 3 komoda**

Apolon PA 3 cupboard  
50 x 37 x 95 cm

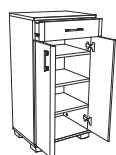

ID 100309  
belo / white

ID 100303  
trešnja / cherry

ID 100312  
hrast / oak

ID 100346  
snežni hrast / snow oak

ID 100352  
tobako / tobacco





# ATINA

**Atina A1**  
50x37x209 cm

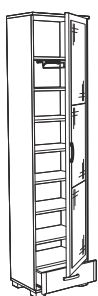

ID 110109  
belo / white



ID 110103  
trešnja / cherry



ID 110112  
hrast / oak



ID 110146  
snežni hrast / snow oak



ID 110152  
tobako / tobacco



Belo  
White

Trešnja  
Cherry

Hrast  
Oak

Snežni hrast  
Snow oak

Tobako  
Tobacco





**Atina A2**  
50 x 209 cm



ID 110209  
belo / white



ID 110203  
trešnja / cherry



ID 110212  
hrast / oak



ID 110246  
snežni hrast /  
snow oak



ID 110252  
tobako / tobacco

## ČIVILUK MATIS/HANGER MATIS

dimenzije/dimensions: 50 x 7 x 149 cm



ID 100609  
belo / white



ID 100603  
trešnja / cherry



ID 100612  
hrast / oak



ID 100646  
snežni hrast /  
snow oak



ID 100652  
tobako / tobacco

## CIPELARI ODISEJ/SHOE CABINETS

**Odisej 3V**

70 x 28 x 120 cm



**HÄFELE**  
MEHANIZAM

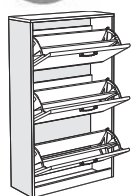

ID 130209  
belo / white



ID 130203  
trešnja / cherry



ID 130212  
hrast / oak



ID 130246  
snežni hrast / snow oak



ID 130252  
tobako / tobacco

**Odisej 4V**

70 x 28 x 157 cm



**HÄFELE**  
MEHANIZAM

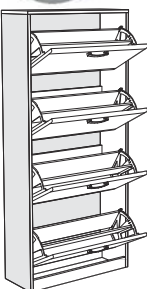

ID 130309  
belo / white



ID 130303  
trešnja / cherry



ID 130312  
hrast / oak



ID 130346  
snežni hrast /  
snow oak



ID 130352  
tobako / tobacco

NAPOMENA: Kompletna šifra elementa se dobija zamenom zvezdica \*\* sa dve cifre iz prikazanih dezena. NOTE: The complete code of an element is obtained by replacing star \*\* with two digits of the displayed pattern.



Belo  
White



Trešnja  
Cherry



Hrast  
Oak

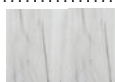

Snežni hrast  
Snow oak



Tobako  
Tobacco



18  
mm

Univer  
Chipboard



M  
Metal

Ručica  
Handle



30  
mm

Zaobljenje  
Soft forming



Kip sistem  
Opening



ABS

1  
mm

Kant traka  
Edge Band



ABS

0,4  
mm

Kant traka  
Edge Band



## KOMBINACIJE

- 1. Apolon PA1 - 50 x 37 x 209 cm
- 2. Apolon PA2 - 50 x 37 x 209 cm
- 3. Apolon PA 3 ogledalo - 50 x 113 cm

- 4. Apolon PA 3 komoda - 50 x 37 x 209 cm
- 5. Apolon PA5 - 50 x 22 x 114 cm
- 6. Atina A1- 50 x 37 x 209 cm

- 7. Atina A2 - 50 x 209 cm
- 8. Odisej 4V - 70 x 28 x 157 cm
- 9. Roma 1- 75x 37 x 95 cm



## KOMBINACIJE

- 1. Apolon PA1 MDF - 50 x 37 x 209 cm
- 2. Apolon PA1 O MDF - 50 x 37 x 209 cm
- 3. Apolon PA 2 MDF - 50 x 113 cm

- 4. Apolon PA 3 MDF ogledalo - 50 x 113 cm
- 5. Apolon PA 3 MDF komoda - 50 x 37 x 95 cm
- 6. Apolon PA5 MDF - 50 x 22 x 114 cm

- 7. Apolon PA 6 MDF - 25 x 37 x 209 cm
- 8. Roma 1 MDF - 75x 37 x 95 cm
- 9. Roma 3 MDF - 112,5x 37 x 95 cm





## TV KOMODE/TV STANDS

---

Od pojave LCD televizora, teško je zamisliti dnevni boravak bez TV komode. TV komode su prilagođene specifičnim dimenzijama u kojima se izrađuju moderni televizori i pružaju savršen oslonac ovoj osetljivoj tehnologiji. Pored svoje osnovne upotrebe, TV komode su praktične i za odlaganje velikog broja predmeta koje želite da držite nadohvat ruke u dnevnom boravku.

*Since the emergence of an LCD TV, it's hard to imagine a living room without a TV stand. TV stands are adapted to the specific dimensions in which modern TVs are made and provide the perfect support for this delicate technology. In addition to its basic use, TV stands are also convenient for storing a large number of items that you want to keep at your fingertips in the living room.*



Made in  
**Serbia**

# LUNA

dimenzije/dimension: 135 x 50 x 67,5 cm



ID 200103  
trešnja / cherry



ID 200113  
hrast / oak



ID 200146  
snežni hrast / snow oak

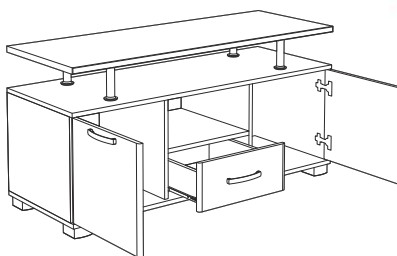

ID 200152  
tobako / tobacco

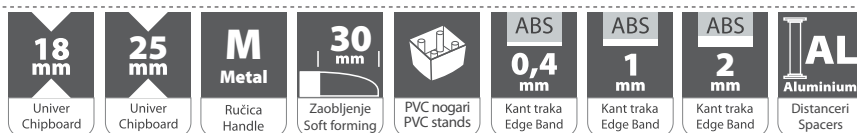



## KOMODE/*CUPBOARDS*

---

Komode su višenamenski komadi nameštaja čiju upotrebu možete beskrajno prilagođavati sopstvenim idejama i potrebama. Bilo da se radi o klasičnim fiokarima, komodama sa policama, ugaonim komodama ili komodama za LCD TV, u pitanju je komad nameštaja koji je pogodan za korišćenje u spavaćim i dnevnim sobama, predsobljima, pa čak i u ostavama.

*Cupboards are multipurpose furniture pieces which use can be adjusted to your own ideas and needs. Whether it's classic trolleys, shelves with shelves, angular chambers or LCD TVs, it's a piece of furniture that is suitable for use in bedrooms and living rooms, anteroom and even in pantries.*



# ROMA 1 MDF

dimenzije/dimension: 75 x 37 x 95 cm



ID 140133  
hrast/bež sjaj  
oak/beige gloss



ID 140114  
tobako/belo sjaj  
tobacco/white gloss



ID 140333  
hrast/ bež sjaj  
oak/beige gloss



ID 140314  
tobako/belo sjaj  
tobacco/white gloss

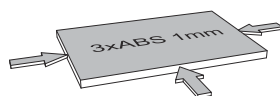
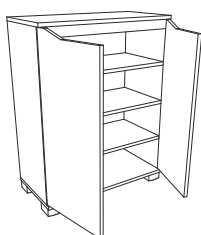

PODOVI I PLAFONI OKANTOVANI SA TRI STRANE!  
TREE SIDE EDGE BANDING OF FLOORS AND CEILING!

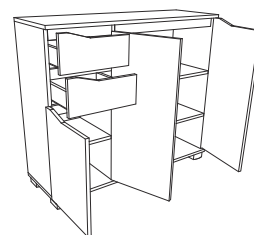

Hrast/bež sjaj  
Oak/beige gloss



Tobako/belo sjaj  
Tobacco/white gloss

Frontovi od medijapana. /Fronts of MDF.  
Italijanska vakuum tehnologija.  
Italian vacuum technology

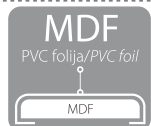

# ROMA 150

dimenzije/dimension: 149,6 x 40 x 80 cm



ID 141209  
belo / white



ID 141252  
tobako / tobacco

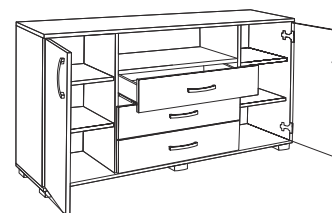

Obrada / Finishing

opciono niša sa rasvetom  
optional open box with lighting

opciono niša sa rasvetom  
optional open box with lighting



ID J141233  
hrast / oak



ID J141246  
snežni hrast / snow oak

Niša / Open box  
šampanj / champagne  
ID 141340

Niša / Open box  
antracit / antracit  
ID 141352



Belo  
White

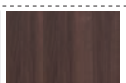

Tobako  
Tobacco



Hrast  
Oak



Snežni hrast  
Snow oak

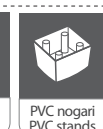

# ROMA 1

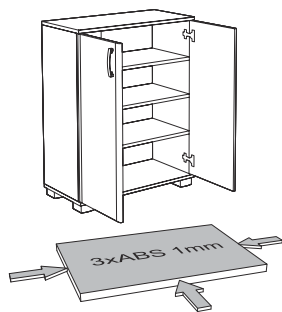

**PODOVI I PLAFONI OKANTOVANI SA TRI STRANE!**  
TREE SIDE EDGE BANDING OF FLOORS AND CEILING!



ID 140109  
belo / white



ID 140103  
trešnja / cherry



ID 140112  
hrast / oak

# ROMA 3

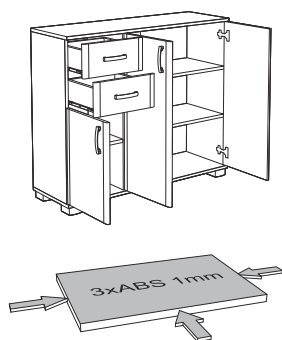

**PODOVI I PLAFONI OKANTOVANI SA TRI STRANE!**  
TREE SIDE EDGE BANDING OF FLOORS AND CEILING!



ID 140309  
belo / white



ID 140303  
trešnja / cherry



ID 140312  
hrast / oak

# ROMA 4

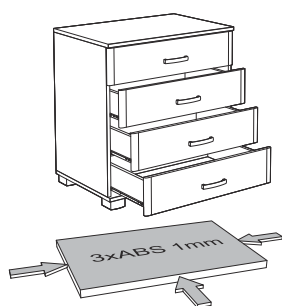

**PODOVI I PLAFONI OKANTOVANI SA TRI STRANE!**  
TREE SIDE EDGE BANDING OF FLOORS AND CEILING!



ID 140409  
belo / white



ID 140403  
trešnja / cherry



ID 140512  
hrast / oak

# ROMA RU

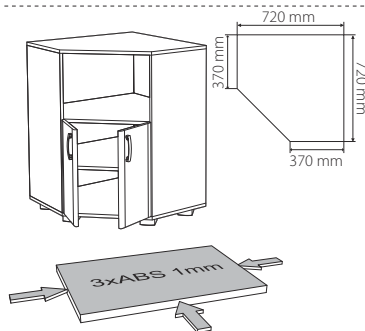

**PODOVI I PLAFONI OKANTOVANI SA TRI STRANE!**  
TREE SIDE EDGE BANDING OF FLOORS AND CEILING!



ID J140709  
belo / white



ID J140703  
trešnja / cherry



ID J140712  
hrast / oak

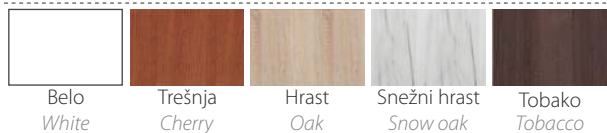

Belo  
White

Trešnja  
Cherry

Hrast  
Oak

Snežni hrast  
Snow oak

Tobako  
Tobacco

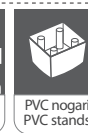

# ROMA 7

dimenzije/dimension: 75 x 37 x 95 cm

dimenzije/dimension: 45 x 52 x 100 cm



ID 140146

snežni hrast / snow oak



ID 140152

tobako / tobacco

dimenzije/dimension: 112,5 x 37 x 95 cm



ID 140346

snežni hrast / snow oak



ID 140352

tobako / tobacco

dimenzije/dimension: 75 x 52 x 80 cm



ID 140446

snežni hrast / snow oak



ID 140452

tobako / tobacco

dimenzije/dimension: 72/37 x 72/37 x 95 cm



ID J140746

snežni hrast / snow oak



ID J140752

tobako / tobacco

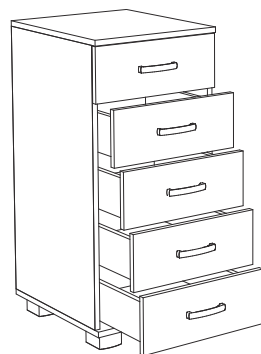

ID 140809

belo / white



ID 140803

trešnja / cherry



ID 140812

hrast / oak



ID 140846

snežni hrast / snow oak



ID 140452

tobako / tobacco

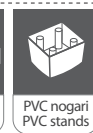
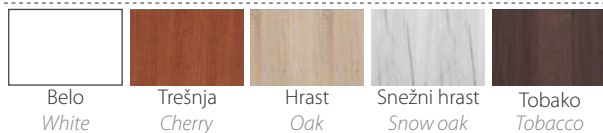





## KLUB STOLOVI / CLUB TABLES

---

Klub stolove od univerza odlikuje jednostavnost, prefinjenost i funkcionalnost. Klub sto se zbog svog savremenog dizajna može prilagoditi različitim prostorima, a može koristiti, pored vašeg doma, i u kancelarijama i ostalim poslovnim objektima. Idealno mesto za odlaganje knjiga, časopisa i posluživanje poslastica za vaše prijatelje.

*Club tables made of chipboard are distinguished by simplicity, sophistication and functionality. A club table, because of its modern design, can be adapted to different spaces, and can be used, aside from your home, in offices and other business facilities. An ideal place for storing books, magazines and serving delicacies for your friends.*

# HERMES

dimenzije/dimension: 90 x 50 x 50 cm



ID J2106\*\*  
hrast/oak



ID J2106\*\*  
snežni hrast/snow oak



ID J2106\*\*  
tobako/tobacco

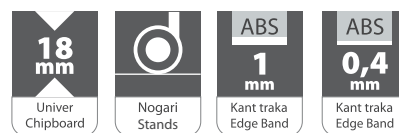
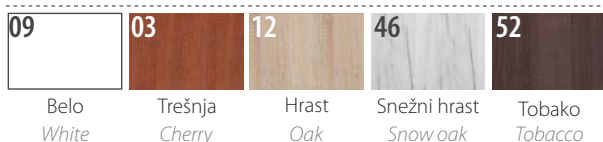

# PIKOLO/PICOLO

dimenzije/dimension: 45 x 38 48 cm



ID 2105\*\*  
hrast / oak



ID 2105\*\*  
snežni hrast / snow oak



ID 2105\*\*  
tobako / tobacco

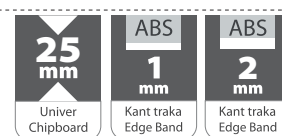
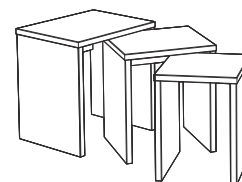

# OGLEDALA MONIKA/MIRROR MONICA

dimenzije/dimension: 65 x 70 cm



ID 3630\*\*  
belo sjaj / white gloss



ID 3630\*\*  
trešnja / cherry



ID 3630\*\*  
hrast / oak



ID 3630\*\*  
snežni hrast / snow oak



ID 3630\*\*  
tobako / tobacco



ID 3630\*\*  
bež / beige

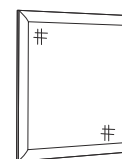



## DNEVNE SOBE/LIVING ROOMS

---

Dizajnerski tim kompanije Matis sa ponosom predstavlja dnevne sobe od medijapana (MDF-a). Upotreba medijapana u izradi nameštaja za dnevne sobe proširuje spektar mogućnosti u izradi i teži da zadovolji i najzahtevnije standarde.

*Matis design team is proud to present Mediapan (MDF) living room. The use of mediapan in making furniture pieces for living rooms expands the range of possibilities in production and strives to satisfy even the most demanding standards.*



Made in  
**Serbia**



# DNEVNA SOBA VENETO / LIVING ROOM VENETO

**Vitrina W55/S / Showcase W55/S**  
55 x 43 x 196 cm  
ID 5705\*\*

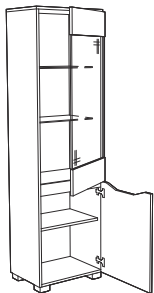

**Zidna polica / Wall shelf**  
102 x 64 x 47 cm  
ID 5706\*\*



**Komoda V160 / Cupboard V160**  
160 x 43 x 90 cm  
ID 5702\*\*

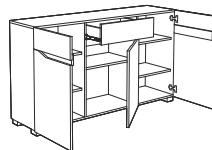

**Komoda V85 / Cupboard V85**  
85 x 43 x 90 cm  
ID 5703\*\*

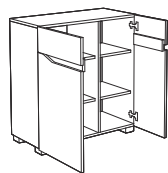

**TV komoda / TV stand**  
160 x 47 x 43 cm  
ID 5704\*\*



**Klub sto / Club table**  
102 x 64 x 47 cm  
ID 5701\*\*

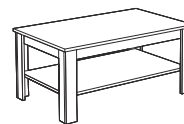

**NAPOMENA:** Kompletna šifra elementa se dobija zamenom zvezdica \*\* sa dve cifre iz prikazanih dezena. **NOTE:** The complete code of an element is obtained by replacing stars\*\* with two digits of the displayed pattern.



Frontovi od medijapana. / Fronts of MDF.  
Italijanska vakuum tehnologija.  
Italian vacuum technology

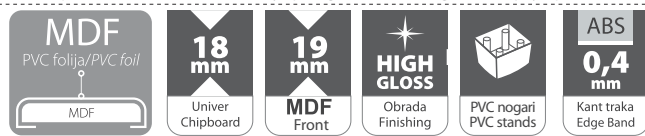



## DNEVNA RUSTIK/*LIVING ROOM RUSTIC*

Za ljubitelje klasične lepote i vanvremenskih dizajnerskih formi proširili smo Rustik kolekciju nameštaja. Znae nas već po nagrađivanim i dokazano kvalitetnim Rustik kuhinjama, koje su osvojile srca i i ukrasile mnoge domove naših vernih kupaca. Predstavljamo Vam dnevni boravak u tradicionalnom stilu sa dodirrom modernizma koji je u dizajniran u skladu sa savremenim dobom u kome živimo.

Staklene vitrine u dve visine sa frontovima iz jednog dela koji su sečeni na CNC mašinama, daju izvanrednu estetsku preciznost i neprikosnoveni kvalitet izrade frontova sa staklenim površinama. Frontovi i vertikalne dekorativne lajsne su načinjeni od medijapana presvučenog rustik folijom na italijanskoj vakuum presi, sa izuzetkom dekorativne rustik lajsne ispod plafona koja se izrađuje od drveta.

*For all lovers of classical beauty and timeless design forms, we have expanded our Rustic furniture collection. You may be already familiar with our awarded and proven high quality Rustic kitchens, that enriched many homes of our loyal customers.*

*We are proudly presenting our living room in traditional style with a touch of mechanism designed in accordance with modern age. Glass showcases in two heights, with fronts made of single element, cutted on CNC machines, are providing an exeptional aesthetic precision and ultimate quality of glass surface fronts processing. Fronts and vertical decorative battens are made of MDF covered with rustic foil on italian vacuum press, with an exception of decorative rustic battens under the ceiling that is made of wood.*

**Rustik biblioteka**

*Rustik bookcase*  
66,5 x 209 x 40,6 cm  
ID 610543



**Rustik staklena vitrina-visoka**

*Rustik showcase-high*  
66,5 x 209 x 40,6 cm  
ID 610743



**Rustik staklena vitrina-niska**

*Rustik showcase-low*  
90,5 x 147,8 x 40,6 cm  
ID 610643



**Rustik TV komoda**

*Rustik TV stand*  
166,5 x 60 x 40,6 cm  
ID 610243



**Rustik komoda**

*Rustik stand*  
166,5 x 84 x 50,6 cm  
ID 610443



**Rustik klub sto**

*Rustik club table*  
101,2 x 60,6 x 45 cm  
ID 610143



**Rustik viseća polica**

*Rustik shelf*  
166,5 x 21,8 x 21,8 cm  
ID 610343

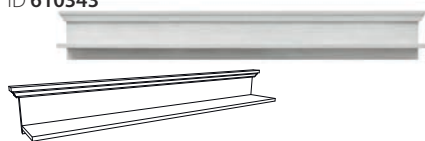

  
rasveta opciono  
lighting optional

**Led transformator**  
*Led transformer*

**Led lampa**  
*Led lamp*



ID 070121

ID 070122



rustik belo  
*rustic white*





**Vitrina W55/S**  
Showcase W55/S  
55 x 42,5 x 195 cm  
ID 5506\*\*

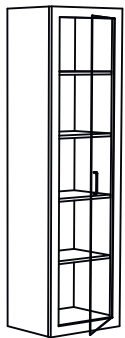

**Vitrina W55**  
Showcase W55/S  
55 x 42,5 x 195 cm  
ID 5505\*\*

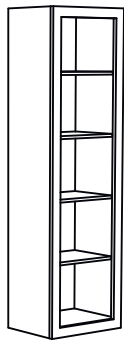

**Zidna polica / Wall shelf**  
1307140 x 24 x 23 cm  
ID 5504\*\*



**Klub sto / Club stand**  
92 x 60 x 47 cm  
belo/white ID 550109

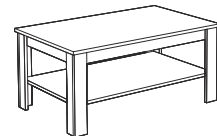

**Komoda W85/**  
Cupboard W85  
85 x 42,5 x 90 cm  
ID 5502\*\*



**Komoda W140**  
Cupboard W140  
140 x 42,5 x 90 cm  
ID 5503\*\*



**TV komoda / TV stand**  
140 x 47,5 x 47 cm  
ID 5507\*\*

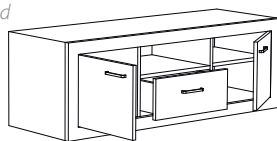

**NAPOMENA:** Kompletna šifra elementa se dobija zamenom zvezdica \*\* sa dve cifre iz prikazanih dezena. **NOTE:** The complete code of an element is obtained by replacing stars\*\* with two digits of the displayed pattern.



41  
San remo / late  
San remo / late



09  
Belo / White





## DNEVNA SOBA WOOD / LIVING ROOM WOOD

**Vitrina W55/S / Showcase W55/S**  
55 x 42,5 x 195 cm  
ID 5506\*\*



**Vitrina W55 / Showcase W55/S**  
55 x 42,5 x 195 cm  
ID 5505\*\*



**Zidna polica / Wall shelf**  
1307140 x 24 x 23 cm  
ID 5504\*\*

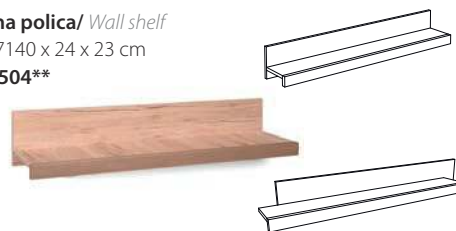

**TV komoda / TV stand**  
140 x 47,5 x 47 cm  
ID 5507\*\*



**Klub sto / Club stand**  
92 x 60 x 47 cm  
san remo ID 550841



**Komoda W85 / Cupboard W85**  
85 x 42,5 x 90 cm  
ID 5502\*\*



**Komoda W140 / Cupboard W140**  
140 x 42,5 x 90 cm  
ID 5503\*\*







## DNEVNA SOBA SIGMA / LIVING ROOM SIGMA

dimenzije/dimensions: 225 x 40 x 199 cm

SIGMA Dnevne sobe kombinacijom materijala i savremenih tehnologija obezbeđuju veoma dug vek trajanja. Izrađene su od oplemenjenog univera debljine 25mm i 18mm sa kvalitetnim ručkama i odstojnicima od aluminijuma. Dnevne sobe Sigma lako se mogu prilagoditi vašim potrebama i zahtevima prostora. Prednost ovih dnevnih soba je ta što se niti jedan element ne kači na vaš zid, tako da je lako prenosiv prilikom rekonstrukcije vašeg dnevnog boravka.

*SIGMA Living Rooms by a combination of materials and modern technologies provide a very long life. They are made of 25 mm and 18 mm thick refined chipboard with quality handles and spacers made of aluminum. Sigma living rooms can easily be adapted to your needs and space requirements. The advantage of these living rooms is that no element is attached to your wall, so it is easily portable when reconstructing your living room.*

Hrast/šampanj  
Oak/champagne  
ID 230150

Snežni hrast/antracit  
Snow oak/antracit  
ID 230146



TELESKOPSKI KLIZAČI  
TELESCOPIC SLIDES

\* Rasveta je uključena u cenu  
\* Lighting is included in the price



Hrast/šampanj  
Oak/champagne



Snežni hrast/antracit  
Snow oak/antracit







## KLUB STO SIGMA / CLUB TABLE SIGMA

dimenzije/dimensions: 102 x 64 x 47 cm



Hrast / Oak  
ID 552112

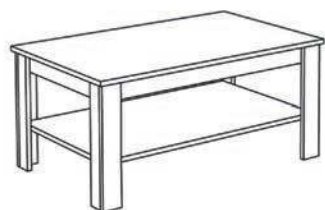

Snežni hrast / Snow oak  
ID 552146



Hrast  
Oak



Snežni hrast  
Snow oak

<b>18 mm</b>	<b>ABS</b>	<b>ABS</b>
Univer Chipboard	<b>1 mm</b>	<b>0,4 mm</b>
	Kant traka Edge Band	Kant traka Edge Band



## SPAVAĆE SOBE/*BEDROOMS*

Svaku prostoriju u stanu možete urediti po vašoj zamisli, ne robujući nikakvim strogo nametnutim pravilima. Ovo naročito važi za spavaću sobu koja treba potpuno da se prilagodi vašim potrebama i shvatanju lepog. Sa druge strane, postoje neke smernice ukoliko želite da sobu uredite u nekom od najčešće korišćenih stilova. U okviru tih smernica, možete slobodno eksperimentisati, ali njih treba imati na umu kao olakšicu u traženju pravog rešenja.

*You can arrange every room in the apartment according to your idea, not be guided by strictly imposed rules. This is especially true for a bedroom that needs to be fully adapted to your needs and understanding of beauty. On the other hand, there are some guidelines if you want to arrange room in one of the most common used styles. Within these guidelines, you can freely experiment, but they should be kept in mind as a relief in finding the right solution.*

Made in  
**Serbia**





1 Noćni ormarić Matis 3F / Nightstand Matis 3F

2 Ležaj Korleone / Bed Korleone

3 Garderobier Fortuna F3 / Wardrobe Fortuna F1

4 Fotelja Grazia / Armchair Grazia

5 Tabure Grazia / Tabouret Grazia

1 Komoda "Roma 4" / Cupboard "Roma 4"

2 AP 230 Elegance line

3 Woody Soft New

4 Noćni ormarić Elegance line / Nightstand Elegance line







- 1 Noćni ormarić "Matis 2F" / Night stand "Matis 2F"
- 2 Bračni krevet "Intro New" / Double bed "IntroNew"

- 3 Ormar IVA 4K2FO / Wardrobe IVA 4K2FO
- 4 Komoda "Roma 150" / Cupboard "Roma 150"

- 5 Niša sa rasvetom (opciono) / Open box with lighting (optional)

- 1 Noćni ormarić "Matis 2F" / Night stand "Matis 2F"
- 2 Bračni krevet "Intro New" / Double bed "IntroNew"

- 4 Klub set Pikolo/Club set Piccolo
- 3 Komoda "Roma 150" / Cupboard "Roma 150"

- 5 Tabure Modena/Tabouret Modena
- 6 Garderobier GD 180/Wardrobe GD 180





- 1 Ogledalo "Monika" / Mirror "Monica"
- 2 Komoda "Roma 4" / Cupboard "Roma 4"
- 3 Noćni ormarić "Alfa" / Night stand "Alfa"
- 4 Bračni krevet "Intro New" / Double bed "IntroNew"
- 5 Garderobier Fortuna F3 / Wardrobe Fortuna F3
- 6 Garderobier Fortuna F75 / Wardrobe Fortuna F75
- 7 Garderobier Fortuna F1 / Wardrobe Fortuna F1

- 
- 1 Noćni ormarić "Matis 2F" / Night stand "Matis 2F"
  - 2 Krevet samac "Woody BOX" / Single bed "Woody Box"
  - 3 Ormar IVA 3K2F / Wardrobe IVA 3K2F







## GARDEROBERI FORTUNA SOFT / WARDROBES FORTUNA SOFT

### NOVI MEHANIZAM

Uveden je novi mehanizam od nemačkog proizvođača Hettich. Ovaj sistem znatno ubrzava montažu vrata jer se veći točkići samo jednim potezom pozicionira na šinu. Osim toga, bez ikakvog šrafjenja, prilikom ispadanja klizača iz šine, korisnik može sam da vrati klizač na postojeću šinu.



### NEW MECHANISM

We implemented new mechanism by german producer Hettich. This system is significantly improving efficiency of door mounting since the wheel is positioned on the sliding rail by one single step. Another advantage is that during eventual pulling out the wheel off the leading rail, user can easily mount the wheel back into the rail.



**DOKAZAN KVALITET - Nemački mehanizam sa aluminijumskim vodičama**  
Inovacija u upotrebi kliznih mehanizama. Jednim laganim klikom vraćate plakar u ležište, a da pritom ne brinete o dodatnom održavanju.

German mechanism with aluminium rail leaders.  
Innovation in sliding mechanisms use. By one simple click you can pull the wardrobe doors back, without any additional maintenance needs.

### EKSCENTARVEZA - Veliki broj sklapanja i rasklapanja

Daje čvrstinu i stabilnost plakarima, kao i dodatnu sigurnost ukoliko se morate često seliti.

**EXCENTER JOINT** - Great number of mountings and dismountings Provides firmness and stability for wardrobes, as well as additional safety if you are to move frequently.

### 100% UKLOPIVOST U SVE PROSTORE

Veliki broj elemenata različitih širina Vam omogućava slobodu da kreirate svoju idealnu kombinaciju, kao što je to slučaj sa plakarima izrađenim po meri.

### 100% FITTING INTO ALL KINDS OF SPACES

Great number of elements made in various widths are providing creative freedom for our customers creating their own ideal configuration, the same approach is evident in custom-made wardrobes option we are offering.

### PREKLOPNA VRATA - Ušteda prostora!

Veoma praktična kada imate manjak prostora, otvoreno krilo fronta zauzima maksimalno 25 cm.

### FOLDING DOORS - SPACE SAVING!

Very functional if your space is smaller, opened front door is occupying maximum of 25cm

### MASIVNE FIOKE!

Male fioke su uvek slaba tačka kod gotovih plakara, mi smo ovu slabost otklonili velikim fiokama - dimenzija 75 x 14 cm!

### MASSIVE DRAWERS

Small drawers are always the weak point of wardrobes, we successfully eliminated this weakness with big drawers, dimensions of 75cmx24cm

### MATIS SPECIJALNA POGODNOST!

Ugao fortuna element, izdvaja se od ostalih na tržištu, svojom praktičnošću, stabilnošću i cenom! Eliminirate slepe uglove u vašem stanu, iskoristite svaki milimetar i uklapajte bez ograničenja!

### MATIS SPECIAL OFFER!

Corner element Fortuna, distinctive on market for its functionality, stability and price! Eliminate "blind" corners of your living space using every millimeter and combining without setted limits.

**NAPOMENA:** Kompletna šifra elementa se dobija zamenom zvezdica \*\* sa dve cifre iz prikazanih dezena. **NOTE:** The complete code of an element is obtained by replacing stars\*\* with two digits of the displayed pattern.

<b>09</b> Belo / White	<b>03</b> Trešnja / Cherry	<b>12</b> Hrast / Oak	<b>46</b> Snežni hrast / Snow oak	<b>52</b> Tabako / Tabaco	<b>Soft forming</b> Obrada / Finishing	<b>Hanger</b> Gard. sipka Hanger	<b>30 mm</b> Zaobljenje Soft forming	<b>18 mm</b> Univer Chipboard	<b>ABS</b> <b>0,4 mm</b> Kant traka Edge Band	<b>M</b> Metal Ručica Handle
---------------------------	-------------------------------	--------------------------	--------------------------------------	------------------------------	---	-------------------------------------	---	----------------------------------	---	------------------------------------



**F1 •**  
50 x 52 x 222 cm  
ID 3040\*\*

**F2 •**  
100 x 52 x 222 cm  
ID 3041\*\*

**F2 POL •**  
100 x 52 x 222 cm  
ID 3042\*\*

**F3 •**  
150 x 52 x 222 cm  
ID 3043\*\*

**F75 •**  
75 x 52 x 222 cm  
ID 3045\*\*

**FU •**  
88/52 x 87/52 x 222 cm  
ID 3046\*\*

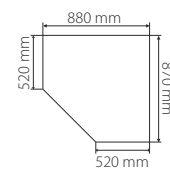
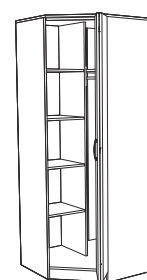
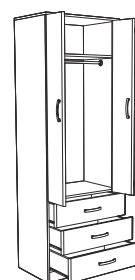
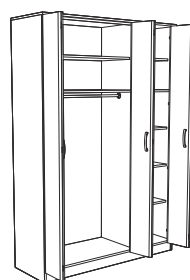



## GARDEROBERI IVA / WARDROBES IVA



**NAPOMENA:** Kompletna šifra elementa se dobija zamenom zvezdica \*\* sa dve cifre iz prikazanih dezena. **NOTE:** The complete code of an element is obtained by replacing stars\*\* with two digits of the displayed pattern.

<b>09</b>	<b>12</b>	<b>46</b>
Belo / White	Hrast / Oak	Snežni hrast / Snow oak

<b>16 mm</b> Univer Chipboard	<b>ABS</b> <b>0,4 mm</b> Kant traka Edge Band	<b>ABS</b> Ručica Handle	<b>Hanger</b> Gard. šipka Hanger
----------------------------------	---	-----------------------------	-------------------------------------

### Ormar "Iva K2 POL 200"

82 x 53 x 200 cm

Wardrobe "Iva K2 POL 200"



hrast / oak  
ID 3113\*\*

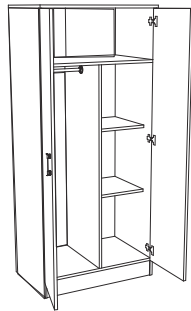

### Ormar "Iva K3 "

123 x 53 x 200 cm

Wardrobe "Iva K3"



hrast / oak  
ID 3114\*\*

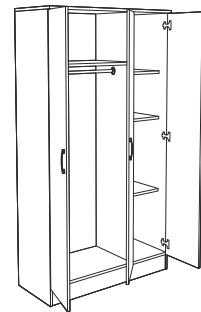

### Ormar "Iva 3K2F"

123 x 53 x 200 cm

Wardrobe "Iva 3K2F"



hrast / oak  
ID 3111\*\*

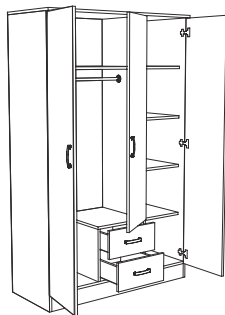

### Ormar "Iva 3K2F O"

123 x 53 x 200 cm

Wardrobe "Iva 3K2F O"



hrast / oak  
ID 3112\*\*

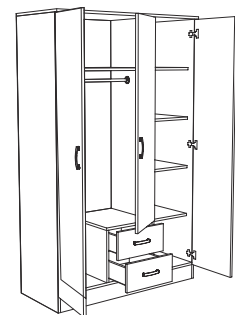

### Ormar "Iva 4K2F "

123 x 53 x 200 cm

Wardrobe "Iva 4K2F"



hrast / oak  
ID 3116\*\*

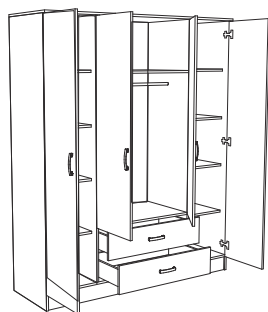

### Ormar "Iva 4K2FO "

123 x 53 x 200 cm

Wardrobe "Iva 4K2FO"



hrast / oak  
ID 3117\*\*

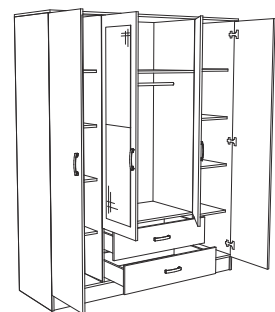





## GARDEROBER GD 240/WARDROBES GD 240

dimenzija/dimension: 240 x 64 x 220 cm

Konstrukcija gornjeg klizača obezbeđuje sigurnost u eksploataciji da ne bi došlo do ispadanja frontova iz aluminijumskih vodica i dozvoljava eventualna odstupanja u horizontalnosti ormara do 8 mm.

*The construction of the upper slide secures the usage, so it cannot happen for fronts (doors) to fall out from the aluminium leads and allows eventual horizontal deviations up to 8 mm.*



ID 521114  
belo-belo / white-white



ID 521109  
belo-lila / white-purple



ID 521116  
belo-crno / white-black

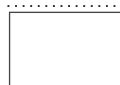

Belo  
White



Belo-lila  
White-purple



Belo-crno  
White-black



Arlington orah  
Arlington walnut  
Champagne



Hrast-šampanj  
Oak-champagne



Snežni hrast-antrac.  
Snow oak-antrac.



18  
mm

Univer  
Chipboard



ABS

1  
mm

Kant traka  
Edge Band



0,4  
mm

Kant traka  
Edge Band

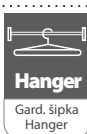

Gard. šipka  
Hanger



Slide

Otvaranje  
Opening

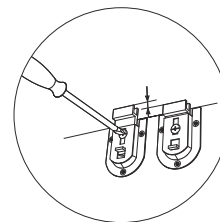
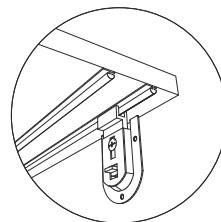
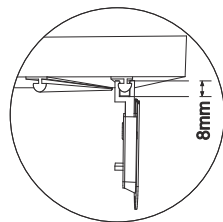

**Aluminijumske vođice**  
Aluminium leads



**ID 521142**  
arlington orah / arlington walnut



**ID 521112**  
hrast-šampanj / oak-champagne



**ID 521146**  
snežni hrast-antracit / snow oak-antracit

Vrata se isporučuju sa namontiranim rukohvatima. / Doors are delivered with mounted handles





## GARDEROBER GD 180 / WARDROBES GD 180

dimenzija/dimension: 180 x 64 x 220 cm

Garderoberi GD 180 pružaju dovoljno prostora za odlaganje sve vaše garderobe. Izrađeni su od oplemenjenog univera debljine 18 mm sa aluminijumskim vođicama i rukohvatima. Unutar garderobera pored poprečnih polica nalazi se i garderobna šipka i pomerljive palice. Garderobler GD 180 odlikuje klasičan stil i elegancija.

Aluminijumski rukohvat / Al handle

*Wardrobe GD 180 provides enough space to store all your wardrobe. They are made of a refined 18 mm thick univiera with aluminum guides and grips. Inside the wardrobe, with aluminium, there is a locker bar and moving rods. The Wardrobe GD 180 features classic style and elegance.*



ID 521609  
belo-belo / white-white



ID 521646  
snežni hrast-antracit / snow oak-antracit



ID 521612  
hrast-šampanj / oak-champagne



Belo  
White



Snežni hrast-antrac.  
Snow oak-antrac.



Hrast-šampanj  
Oak-champagne



18 mm

Univer  
Chipboard



ABS

1 mm

Kant traka  
Edge Band

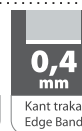

0,4 mm

Kant traka  
Edge Band



Hanger

Gard. šipka  
Hanger



Slide

Otvaranje  
Opening





## GARDEROBER GD 150/WARDROBES GD 150

dimenzija/dimension: 150 x 64 x 220 cm

Klizni ormar GD 150 obećava enterijersku praktičnost i maksimalnu iskorišćenost prostora. Unutrašnji prostor ovog modela poseduje set polica i garderobnu šipku. Dubina ormara od 64 cm omogućava nesmetano odlaganje odeće bez gužvanja. Elementi ormara koji su izloženi habanju, a to su frontovii bočne stranice, okantovani su ABS trakom debljine 1 mm.

Aluminijumske vođice / Al trails

*Sliding closet GD 150 promises interior practicality and maximum space utilization. The interior of this model has a set of shelves and a wardrobe. The depth of the cabinet of 64 cm allows unhindered unloading of clothes. Elements of the wardrobe that are exposed to wear, which are the fronts and sides, are stained with an ABS strip of thickness of 1 mm.*



ID 524009  
belo-belo/ white-white



ID 524046  
snežni hrast-antracit/ snow oak-antracit



ID 524012  
hrast-šampanj/ oak-champagne



Belo  
White



Snežni hrast-antrac.  
Snow oak-antrac.



Hrast-šampanj  
Oak-champagne





## GARDEROBER GD 120 / WARDROBES GD 120

dimenzija/dimension: 120 x 64 x 220 cm

Garderoberi GD 120 pružaju dovoljno prostora za odlaganje vaše garderobe. Izrađeni su od oplemenjenog univera debljine 18 mm sa aluminijumskim vođicama i rukohvatima. Unutar garderobera pored poprečnih polica nalazi se i garderobna šipka.

Aluminijumski rukohvat / Al handle

*Wardrobe GD 120 provides plenty of space to store your wardrobe. They are made of 18 mm thick finned univer with aluminum guides and handrails. Inside the wardrobe, next to the cross-poles, there is a locker bar.*



ID 523009  
belo-belo/ white-white



ID 523046  
snežni hrast-antracit/ snow oak-antracit



ID 523012  
hrast-šampanj/ oak-champagne



Belo  
White



Snežni hrast-antrac.  
Snow oak-antrac.



Hrast-šampanj  
Oak-champagne







## AP 280 PLAKAR / WARDROBES AP 280

dimenzija/dimension: 276 x 64 x 220 cm

Američki plakar APM 280 projektovan je da svojim dizajnom i upotrebnim prostorom donese maksimalnu organizaciju u ambijentu spavaće sobe. Raskošnih dimenzija i unutrašnjim rasporedom sa policama u središnjem delu i sa gaderobnim šipkama levo i desno pozicioniranim, zadovoljiće potrebe za odlaganjem garderobe. Dva dela američkog plakara sadrže garderober šipku, a jedan deo je podeljen policama za odlaganje garderobe. Izrađen je od oplemenjenog univera 18mm sa ramom od bukovog drveta koji daje dodatnu čvrstinu.

*The American closet APM 280 is designed to bring the maximum organization in the bedroom's surroundings with its design and use space. The luxurious dimensions and internal arrangement with the shelves in the center and with gaderobic rods left and right positioned will satisfy the need for the disposal of the wardrobe. Two parts of the American closet contain a wardrobe, and one part is divided into shelves for changing clothes. It is made of 18mm high-grade univera with a beech wood frame that gives extra strength.*



### NOVI MEHANIZAM - Bez problema i buke

Proizvođač mehanizma je unapredio sistem gornjih točkica. Umesto jednog većeg, sada postoje dva koja se rotiraju nezavisno jedan od drugog svaki na svoju površinu naleganja, pa u slučaju i da je šina malo deformisana, oni omogućavaju nesmetano kretanje vrata.

### NEW MECHANISM - No problem - No noise

The mechanism producer has improved the system of upper wheels. Instead of one big wheel there are now two wheels which rotate independently from each other, so small deformities of the leading lines make possible the sliding of the doors.



### LAKA NIVELACIJA - Nivelacija poda ormara na 6 nogara

Ispod poda ormara je ugrađeno 6 nogarića za lako besprekorno nivelisanje poda ormara. To je važno jer se u toku eksploatacije vrata veoma lako i bešujno otvaraju, a uz pomoć ugrađenog SlowMotion mehanizma, veoma lako i usporeno zatvaraju.

### EASY LEVELING - Leveling the closet floor on 6 legs

Below the wardrobe floor 6 legs for easy leveling are installed. This is important for easy and silent door opening, and with the integrated Slow-Motion mechanism, very easy and slow closing.



ID 320740

hrast-šampanj/ oak-champagne



Oznaka odgovornog šumarstva



ID 320746

snežni hrast-antracit/snow oak-antracit

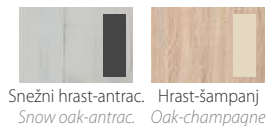

Snežni hrast-antracit / Hrast-šampanj  
Snow oak-antracit / Oak-champagne



18 mm

Univer Chipboard



0,4 mm

Kant traka Edge Band



Nivelacija Adjusting



Otvaranje Opening



Gard. šipka Hanger



Rukohvat Handle



Zatvaranje Closing





## NOĆNI ORMARIĆI/NIGHTSTANDS

---

Koliko ste samo puta ustajali noću i potpuno se razbudili da biste otišli po čašu vode. Sa noćnim ormarićima kompanije Matis, više nećete morati da ustajete iz tople postelje, jer će Vam sve potrebštine uvek biti lako dostupne. Noćni ormarići posebno su dragi ljubiteljima dobre knjige, ili onima koji ne mogu da zamisle ni trenutak bez mobilnog telefona nadohvat ruke.

*How many times did you get up and was totally awake to go for a glass of water? With Matis nightstands you will no longer have to get out of the warm bed, as all you need will be always easy to access. Nightstands are especially dear to people who love to read or to the ones that can not imagine a moment without a mobile phone at their fingertips.*

# MATIS 2F

dimenzija/dimension: 49 x 38 x 45,5 cm



**ID 360209**  
belo / white



**ID 360212**  
hrast / oak



**ID 360203**  
trešnja / cherry



**ID 360252**  
tobako / tobacco



**ID 360246**  
snežni hrast-antracit  
snow oak-antracit

WOODY FRONTOM - Mogućnost doplate - Woody fronts - Optional

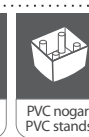
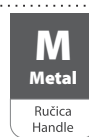
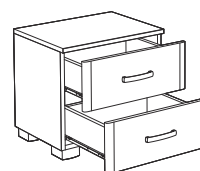

# MATIS 3F

dimenzija/dimension: 49 x 38 x 65 cm



**ID 360309**  
belo / white



**ID 360512**  
bardolino-hrast /  
bardolino-oak



**ID 360352**  
tobako / tobacco



**ID 360346**  
snežni hrast-antracit  
snow oak-antracit

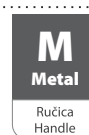
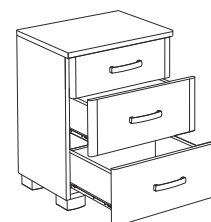

# ALFA

dimenzija/dimension: 40 x 43 x 52 cm



**ID 360109**  
belo / white



**ID 360312**  
hrast / oak



**ID 360103**  
trešnja / cherry



**ID 360152**  
tobako / tobacco



**ID 360146**  
snežni hrast / snow oak

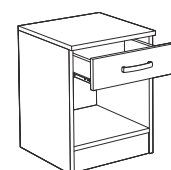



## KREVETI OD PUNOD DRVETA BUKVE/SOLID WOOD BEDS

Savremen način i ubrzan tempo života opterećen stresom, ostavlja nam sve manje vremena za odmor, što ozbiljno ugrožava naše zdravlje. Zdrav san i odmor postali su bitni faktori poboljšanja kvaliteta života. Istovremeno, savremeni trendovi potrošačkog društva i sve veća potreba za dodatnim prostorom za odlaganje stvari, uslovljavaju da životno okruženje moramo opremiti maksimalno funkcionalno. Dugogodišnjim iskustvom u proizvodnji nameštaja i osluškivanjem želja i potreba kupaca, pokušali smo da napravimo više modela kreveta visokog kvaliteta i estetike. Koliko smo u tome uspeli prosudite sami.

*Modern and fast way of life full of stress is leaving us with less time to rest, this can seriously threaten our health. Healthy sleep and rest have become important factors for improving the quality of life. At the same time, current trends of the consumer society and the growing need for additional space to store things are forcing us to arrange our living space with maximum functionality. Years of experience in the furniture production and listening to the wishes and needs of our customers, made us make more models of beds with high quality and aesthetics. Did we succeed? Please judge for yourself.*

Made in  
**Serbia**



Oznaka  
odgovornog šumarstva



# Opšte karakteristike kreveta od drveta

## General characteristics of solid wood beds



### Proverite KVALITET FARBANJA

Kompletno automatizovana linija za farbanje i sušenje elemenata

Automatizovanje linije za farbanje osim velike produktivnosti donose kontinualan i visok nivo kvaliteta tretiranih elemenata.

### CHECK OUR PAINTING SYSTEM

Completely automatized line for painting and drying elements

Automatizing the line for painting, apart from its high productivity, is providing continuity and high quality level of treated elements.



### Čvrsta VEZA

Metalni sistem spajanja stranica kreveta

Za razliku od sličnih proizvoda na tržištu, kod kojih se spajanje stranica kreveta vrši vijcima za drvo bez tiplova, naši kreveti imaju sigurne, posebno dizajnirane, skrivene metalne spojnice renomiranog italijanskog proizvođača, što uz drvene tiplove omogućava čvrst spoj i dugogodišnju stabilnost.

### Strong CONNECTION

Metal system of bed side connecting

Unlike similar products on the market, where the connecting of the bed sides is done with bolts without anchor, our beds have secure, specially designed, hidden metal clips made by renown Italian manufacturer, which, together with wooden wedge enables tight connection and long-term stability.



### Elastična i sigurna PODLOGA

Pod kreveta

Podloge od šperploče daju ravnu i stabilnu osnovu za dušek čime se obezbeđuje njegovo ravnomerno opterećenje. Time je omogućen zdrav i pravilan položaj kičmenog stuba i celog tela tokom odmora i sna. Razmaci između letvica omogućavaju dobru cirkulaciju vazduha oko duška i njegovo provetranje.

### Well LINED

The bed with the beech laths floor

Lath floor of the bed gives a flat and stabile base for the mattress, thus providing its even loading. This enables a healthy and correct position of the spinal column and the whole body during rest and sleep. The spaces between the laths allow good air circulation around the mattress and its ventilation.



### Siguran OSOLONAC

Savršena podloga za svaki dušek

Na srednju potpurnu letvu kreveta, na koju su vezane letvice, montirana su dva nogara za podešavanje visine, tako da se vrlo jednostavno i lako može dobiti savršeno ravna podloga za dušek, bez obzira na eventualne nedostatke poda na kome se krevet nalazi.

### Strong SUPPORT

Perfect background for every mattress

At the middle of support rail on the bed, where laths are attached, we have mounted two legs, in order to allow height adjustment of the bed. This way, very simple and easily you get a perfectly flat surface for a mattress, regardless to the floors of the floor where the bed is located.

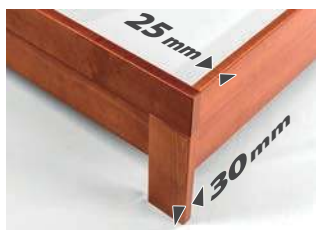

### Život sa PRIRODOM

Srednji metalni oslonac za potpurnu gredu

Kreveti pravljani od punog bukovog drveta, osim što unose toplinu prirodnih materijala u vaš dom, postojani su i dugovečni. Bočne stranice izrađuju se od 25 mm, a čeonu stranu i nogari od 30 mm debljine drvenih ploča što daje posebnu stabilnost i čvrstinu.

### Live with NATURE

Natural materials in your home

Beds made of beech wood, are bringing the warmth of natural materials to your home. They are stabile and long lasting. The sides of the bed are made of 25 mm, the side walls and the wooden trestles of 30 mm solid wood plate, which gives a special stability and firmness to the bed.



### Ispod KREVETA

Lako dostupno i uvek čisto

Kako bi spavaća soba bila mesto zdravog odmora, veoma je važna mogućnost lakog čišćenja. Zato posebno ističemo da su svi WOODY kreveti nogarima odignuti od poda, koji je tako dostupan za održavanje

### Under THE BED

Easy available and always clean

In order to have bedroom a healthy place to rest, it is very important that they are easily cleaned. Therefore we have especially emphasized that all "WOODY" beds are lifted on trestles, making the floor absolutely accessible for maintenance.



### Dobro PAKOVANJE

Potpuna zaštita od oštećenja

Svi delovi Woody kreveti se pakuju u kartonske kutije. Uglovi i drugi delovi osjetljivi na oštećenja su dodatno obloženi i zaštićeni stiroporom, te je mogućnost bilo kakvog oštećenja pri transportu svedena na minimum.

### Good PACKING

Complete protection from damage

All parts of "Woody" beds are packed in cardboard boxes. Edges and other parts susceptible to damaging are additionally coated and protected with Styrofoam, this way, the possibility of any damaging during transportation is reduced to minimal.



## WOOD BASIC

## KREKET OD PUNOD DRVETA BUKVE/SOLID WOOD BEDS

MatisWOOD Vam predstavlja novi krevet iz Woody serije, pod nazivom Woody Basic. Ekonomičan i konstrukcijski stabilan krevet od masiva uživa neograničenu primenu u opremanju domova i razolikih smeštajnih objekata. Radi se u dve dimenzije, 160cm i 90cm i ima za cilj da tržištu ponudi kvalitetan, lep i dugovečan proizvod po veoma povoljnoj ceni. U upotrebi su ekološki ispravni lakovi i bajc premazi na vodenoj bazi, kao i kod svih naših kreveta od punog drveta.

Woody Basic je četvorodelni montažno-demontažni krevet sa podnim letvicama od bukovog drveta. Data je opcija dokupljivanja fioke i prednje maske na uznožju - koja vizuelno zaklanja prostor ispod kreveta. Fioka može biti prostor za odlaganje stvari ili mesto za pomoćni dušek.

*MatisWOOD is presenting our new bed in Woody series, under the item title Woody Basic. Solidwood bed, with its stable base of subconstruction and economical side at the same time, is enabling limitless design solutions in furnishing homes and variety of accomodation spaces. This bed is produced in two dimensions, 160cm and 90cm with an aim to offer longlasting and attractive product of high quality at quite affordable price. Paints and polishings used are waterbased and ecologically approved, same are used in all our solidwood beds productions.*

*Woody Basic is four-parts mounting-dismounting bed with subconstruction laths made of beech wood. Additionally, you may buy an extra bedstorage box and front musks for footer- visually covering the space under the bed. The drawer can be used for an extra mattress or stacking of items.*



Made in  
**Serbia**



Oznaka  
odgovornog šumarstva



1. BRAČNI KREKET  
1.DOUBLE BED

dimenzija/dimension: 147/167/187x207 cm  
dimenzija za dušek/dimension for mattress: 140/160/180 x 200 cm



**ID 348309**  
belo / white



**ID 348301**  
bukva / beech



**ID 348312**  
hrast / oak



**ID 348352**  
tobako / tobacco

2.FIOKA KREVETA /DRAWER  
dimenzija/dimension: 80 x 190 cm



MOGUĆNOST DOPLATE ZA FIOKU  
DRAWER-OPTIONAL



**ID FIO 001**  
belo / white



**ID FIO 004**  
bukva / beech



**ID FIO 002**  
hrast / oak



**ID FIO 003**  
tobako / tobacco

Šifre se odnose na krevet dimenzija 160x200./The codes refer to the bed dimensions 167x207 cm  
Letvice od špera - 40 mm širine su uračunate u cenu kreveta./Plywood boards - 40 mm wide are included in the price of the bed.

3. MASKA FIOKE /DRAWER MASK  
dimenzija/dimension: 90/144/160/180 cm

Šifre se odnose na maske kreveta dimenzija 160x200./The codes refer to 160x200 bed masks.

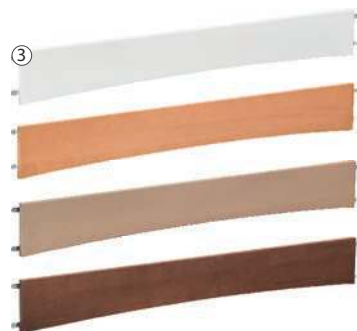

**ID UKL16020009**  
belo / white

**ID UKL16020001**  
bukva / beech

**ID UKL16020012**  
hrast / oak

**ID UKL16020052**  
tobako / tobacco

3. MASKA FIOKE /DRAWER MASK  
dimenzija/dimension: 90/144/160/180 cm

Šifre se odnose na maske kreveta dimenzija 90x200./The codes refer to 90x200 bed masks.



**ID UKL9020009**  
belo / white

**ID UKL9020001**  
bukva / beech

**ID UKL9020012**  
hrast / oak

**ID UKL9020052**  
tobako / tobacco

1.SAMAC  
1.SINGLE

dimenzija/dimension: 97x207 cm  
dimenzija za dušek/dimension for mattress: 90 x 200 cm



**ID 348209**  
belo / white



**ID 348201**  
bukva / beech



**ID 348212**  
hrast / oak



**ID 348252**  
tobako / tobacco

2. FIOKA KREVETA /DRAWER  
dimenzija/dimension: 80 x 190 cm



MOGUĆNOST DOPLATE ZA FIOKU  
DRAWER-OPTIONAL



**ID FIO 001**  
belo / white



**ID FIO 004**  
bukva / beech



**ID FIO 002**  
hrast / oak



**ID FIO 003**  
tobako / tobacco

Šifre se odnose na krevet dimenzija 90x200./The codes refer to the bed dimensions 97x207 cm  
Letvice od špera - 40 mm širine su uračunate u cenu kreveta./Plywood boards - 40 mm wide are included in the price of the bed.

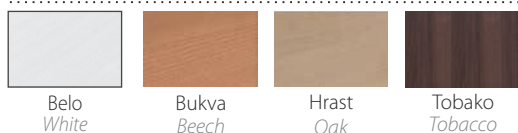

Belo  
White

Bukva  
Beech

Hrast  
Oak

Tobako  
Tobacco





## WOOD PREMIER

### KREKET OD PUNOD DRVETA BUKVE/SOLID WOOD BEDS

Krevet Premier je novi krevet fabrike MatisWOOD koji u sebi pomiruje autentičan dizajn i visok kvalitet izrade u svom cenovnom rangu. Trudili smo se da Vam ponudimo autentičan dizajnerski proizvod po pristupačnoj ceni i kao takav, Premier je redak komad nameštaja na našem tržištu.

U upotrebi su ekološki ispravni lakovi i bajc premazi na vodenoj bazi, kao i kod svih naših kreveta od punog drveta. Podnicu čine letvice od šper ploče, oslonjene na uzdužnoj potpornoj srednjoj letvi koja se oslanja na dva dodatna nogarića sa štel šrafovim - čime je nivelacija kod neravnih podova dodatno olakšana. Prednja maska na uznožju i letvice za dušek su uračunate u cenu. Proizvodi se u dve dimenzije 90cm i 160cm. Fioka je ista kao kod Woody Basic kreveta i ima dvojak namenu, za odlaganje stvari ili za pomoćni dušek.

*Our bed PREMIER is new bed produced in our factory MatisWOOD successfully emphasizing an authentic design and high quality of production in its price range. Our goal is to offer the product that is authentically designed and at affordable price at the same time. For being such a product, Premier bed is quite unique peace of furniture on our market. Paints and polishings used are waterbased and ecologically approved, same are used in all our solidwood beds productions. Bed subconstruction floor is made of plywood laths, placed on horizontal supporting lath that is supported with two extra stands with steel screws- providing additional simplified adjustment in cases of floes of the floors. Front footer mask and mattress laths are included in price. Premier bed is produced in two dimensions, 90cm and 160cm. Bedstorage box is the same like in Woody Basic beds with double purpose, for an extra mattress or stacking items.*



Made in  
**Serbia**



Oznaka  
odgovornog šumarstva

BRAČNI KREVET /DOUBLE BED

dimenzija/dimension: 167 x 214 x 84,5 cm  
dimenzija za dušek/dimension for mattress: 160 x 200 cm



**ID 347009**  
belo / white



**ID 347012**  
hrast / oak



**ID 347052**  
tobako / tobacco

FIOKA KREVETA /DRAWER

dimenzija/dimension: 80 x 190 cm



**ID FIO 001**  
belo / white



**ID FIO 002**  
hrast / oak



**ID FIO 003**  
tobako / tobacco

**PREDVIĐENO ZA DUŠEK 194x75x16 cm**  
FOR MATTRESS 194x75x16 cm



MOGUĆNOST DOPLATE ZA FIOKU/DRAWER-OPTIONAL

SAMAC /SINGLE

dimenzija/dimension: 97 x 214 x 84,5 cm  
dimenzija za dušek/dimension for mattress: 90 x 200 cm



**ID 347109**  
belo / white



**ID 347112**  
hrast / oak



**ID 347152**  
tobako / tobacco

FIOKA KREVETA /DRAWER

dimenzija/dimension: 80 x 190 cm



**ID FIO 001**  
belo / white



**ID FIO 002**  
hrast / oak



**ID FIO 003**  
tobako / tobacco

**PREDVIĐENO ZA DUŠEK 194x75x16 cm**  
FOR MATTRESS 194x75x16 cm



MOGUĆNOST DOPLATE ZA FIOKU/DRAWER-OPTIONAL

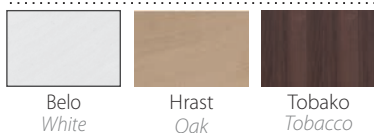

Belo  
White

Hrast  
Oak

Tobako  
Tobacco





## WOODY SOFT LUX

Krevet MASIV Soft LUX, dodir modernog dizajna u skladu sa funkcijom i zagarantovanim kvalitetom. Tapacirano uzglavlje bračnog kreveta od punog bukovog drveta Soft LUX, kompletira krug komfora u vašoj spavaćoj sobi. Visokokvalitetni mebl štof, rezistentan na habanje i cepanje dostupan u tri dezena. Bračni krevet od punog bukovog drveta sa hermetički zatvorenom kutijom za posteljину. Metalni sistem spajanja stranica kreveta. Naši kreveti od drveta, imaju skrivena metalna ojačanja u vidu spojnika, što u kombinaciji sa tiplovima čini neraskidivu vezu i garantuje dugogodišnju stabilnost. Kao podlogu za dušek izabrali smo Latoflex. Metalni ram sa blago pomerljivim zglobnim nosačima letvica proizvodi efekat tzv. plutajuće podloge. Jednim blagim pokretom na gore podižete Latoflex, postavljen na podiznim gasnim amortizerima i sa lakoćom pristupate velikom prostoru za odlaganje.

*Bed MASIV Soft LUX, touch of modern design in accordance with function and guaranteed quality. Upholstered headrest of Soft Lux bed made of beech wood completes the circle of comfort in your bedroom. High quality fabric, wear resistet and tearing resistet, is available in 3 designs. Beech wood double bed with hermetically sealed bedding box. Metal system of connection bed sides. Our wooden beds have hidden metal reinforcement in the form of couplings, which in combination with the anchors make unbreakable bond and guarantee long term stability. We selected Latoflex as a mattress base. Metal frame with movable articulated battens produces the effect of the so-called floating ground. With a slight gentle movement lift up the Latoflex, positioned on the lifting gas shock absorbers and easily access a large storage area.*

## KREKET OD PUNOD DRVETA BUKVE/SOLID WOOD BEDS



Made in  
**Serbia**



Oznaka  
odgovornog šumarstva

BRAČNI KREKET SA TAPACIRANIM UZGLAVLJEM/  
DOUBLE BED WITH UPHOLSTERED HEADBOARD

dimenzija/dimension: 215,5 x 169 x 85 cm  
dimenzija za dušek/dimension for mattress: 160 x 200 cm



ID 346009  
belo / white



ID 346012  
hrast / oak



ID 346006  
wenge/wenge

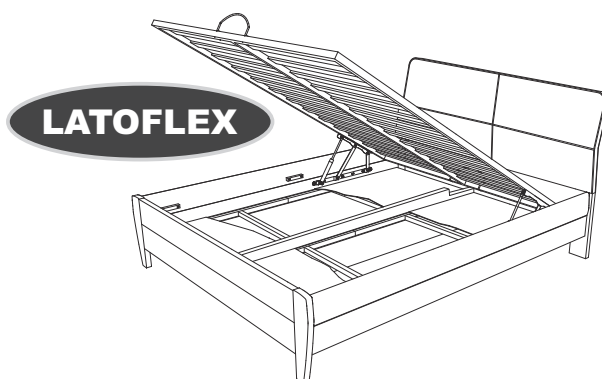

LATOFLEX

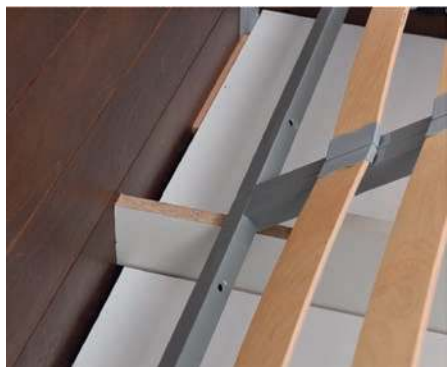

**SIGURNOST**

Središnji oslonac osim što ukrućuje krevet, koristan je i zbog bolje organizacije prostora u kutiji za odlaganje.

*The central support, apart from strengthening a bed is also useful for better organization of the space in the storage box.*



**ZAobljene IVICE**

Sasvim zaslužen i s ponosom, ovaj model kreveta nosi ime SOFT. Primenom softverskih 3D paketa za projektovanje, a potom izradom na kompjuterski upravljanim obradnim centrima i preciznom završnom obradom, osmišljen je krevet na kome su sve ivice zaobljene što, osim izražene estetike, donosi i jednu potpuno novu dimenziju komfora.

?????????

*Completely deserved and proudly this model is named Soft bed. The application of 3D software package for design and then making the same bed on a computer-controlled machines with precise finishing we have designed a bed on which all edges are rounded, therefore besides expressed aesthetics there is an entirely new dimension of comfort.*



**NEĆUJNO I LAGANO** - Do posteljine bez muke i buke

Najsavremeniji mehanizam za podizanje i spuštanje platforme sa dušekom, u koji su ugrađena dva amortizera jačine 750 N, omogućavaju jednostavan pristup prostoru za odlaganje posteljine. Sasvim nećujno i lagano, bez buke i napora.

**SILENT AND LIGHTWEIGHT**

*Get your bedding without the annoyance and noise*

*The most modern mechanism for raising and lowering the mattress platform, that has two integrated gas shock absorbers combined strength of 750 N, allowing easy access to bedding storage. Silently and smoothly, without noise or effort.*



Belo  
White

Hrast  
Oak

Tobako  
Tobacco

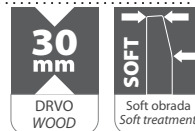





## WOODY SOFT NEW

KREKET OD PUNOD DRVETA BUKVE/SOLID WOOD BEDS

Bračni krevet MASIV Soft New od punog bukovog drveta sa hermetički zatvorenom kutijom za posteljenu. Metalni sistem spajanja stranica kreveta. Naši kreveti od drveta, imaju skrivena metalna ojačanja u vidu spojnice, što u kombinaciji sa tiplovima čini neraskidivu vezu i garantuje dugogodišnju stabilnost. Kao podlogu za dušek izabrali smo Latoflex. Metalni ram sa blago pomerljivim zglobnim nosačima letvica proizvodi efekat tzv. plutajuće podloge. Jednim blagim pokretom na gore podižete Latoflex, postavljen na podiznim gasnim amortizerima i sa lakoćom pristupate velikom prostoru za odlaganje. Pogodan i za male stanove, štedi vam prostor i garantuje komfor!

*Double bed MASIV Soft New made of beech wood with hermetically sealed bedding box. Metal system of connection bed sides. Our wooden beds have hidden metal reinforcement in the form of couplings, which in combination with the anchors make unbreakable bond and guarantee long term stability. We selected Latoflex as a mattress base. Metal frame with movable articulated battens produces the effect of the so-called floating ground. With a slight gentle movement lift up the Latoflex, positioned on the lifting gas shock absorbers and easily access a large storage area.*



Made in  
**Serbia**



Oznaka  
odgovornog šumarstva

BRAČNI KREKET  
DOUBLE BED

dimenzija/dimension: 215,5 x 169 x 85 cm  
dimenzija za dušek/dimension for mattress: 160 x 200 cm



ID 345909  
belo / white



ID 345912  
hrast / oak



ID 345906  
wenge/wenge

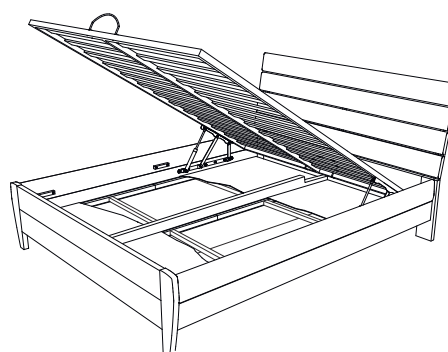

**I ŠTITI I ŠTEDI** - Dvostruka vrednost prostora za posteljinu  
Prostor predviđen za odlaganje posteljine hermetički je zatvoren i onemogućava upadanje prašine. Ovaj prostor, takođe i šteti prostor u spavaćoj sobi, jer vam za odlaganje posteljine nisu potrebne dodatne komode, a soba će uvek biti sređena i uredna.

**PROTECTS AND SAVES** - Double space for bedding  
The space provided for storage of bedding is closed hermetically, preventing the intrusion of dust. This space also saves the space in the bedroom itself, because there is no need for additional cabinets. The room will always be tidy and neat.

**ČVRSTA VEZA** - Metalni sistem spajanja stranica kreveta  
Za razliku od sličnih proizvoda na tržištu, kod kojih se spajanje stranica kreveta vrši vijcima za drvo bez tiplova, naši kreveti imaju sigurne, posebno dizajnirane, skrivene metalne spojnice renomiranog italijanskog proizvođača, što uz drvene tiplove omogućava čvrst spoj i dugogodišnju stabilnost.

**STRONG CONNECTION** - Metal system of bed side connecting  
Unlike similar products on the market, where the connecting of the bed sides is done with bolts without anchor, our beds have secure, specially designed, hidden metal clips made by renown Italian manufacturer, which, together with wooden wedge enables tight connection and long-term stability.

**Ispod KREVETA** - Lako dostupno i uvek čisto  
Kako bi spavaća soba bila mesto zdravog odmora, veoma je važna mogućnost lakog čišćenja. Zato posebno ističemo da su svi WOODY kreveti nogarima odignuti od poda, koji je tako dostupan za održavanje

**Under THE BED** - Easy available and always clean  
In order to have bedroom a healthy place to rest, it is very important that they are easily cleaned. Therefore we have especially emphasized that all "WOODY" beds are lifted on trestles, making the floor absolutely accessible for maintenance.

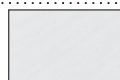

Belo/White



Hrast/Oak



Wenge







## WOODY BOX

Bračni krevet MASIV Soft New od punog bukovog drveta sa hermetički zatvorenom kutijom za posteljinu. Metalni sistem spajanja stranica kreveta. Naši kreveti od drveta, imaju skrivena metalna ojačanja u vidu spojnice, što u kombinaciji sa tiplovima čini neraskidivu vezu i garantuje dugogodišnju stabilnost. Kao podlogu za dušek izabrali smo Latoflex. Metalni ram sa blago pomerljivim zglobnim nosačima letvica proizvodi efekat tzv. plutajuće podloge. Jednim blagim pokretom na gore podižete Latoflex, postavljen na podiznim gasnim amortizerima i sa lakoćom pristupate velikom prostoru za odlaganje. Pogodan i za male stanove, štedi vam prostor i garantuje komfor!

*Double bed MASIV Soft New made of beech wood with hermetically sealed bedding box. Metal system of connection bed sides. Our wooden beds have hidden metal reinforcement in the form of couplings, which in combination with the anchors make unbreakable bond and guarantee long term stability. We selected Latoflex as a mattress base. Metal frame with movable articulated battens produces the effect of the so-called floating ground. With a slight gentle movement lift up the Latoflex, positioned on the lifting gas shock absorbers and easily access a large storage area.*

## KREKET OD PUNOD DRVETA BUKVE/SOLID WOOD BEDS



Made in  
**Serbia**



Oznaka  
odgovornog šumarstva

BRAČNI KREKET  
DOUBLE BED

dimenzija/dimension: 207 x 167,6 x 85 cm  
dimenzija za dušek/dimension for mattress: 160 x 200 cm



**ID 344309**  
belo / white



**ID 344303**  
trešnja / cherry



**ID 344301**  
bukva / beech



**ID 344312**  
hrast / oak



**ID 344306**  
wenge

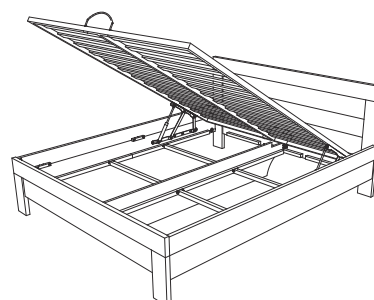

SAMAC  
SINGLE

dimenzija/dimension: 207 x 97,6 x 85 cm  
dimenzija za dušek/dimension for mattress: 90 x 200 cm



**ID 344209**  
belo / white



**ID 344203**  
trešnja / cherry



**ID 344201**  
bukva / beech



**ID 344212**  
hrast / oak



**ID 344206**  
wenge

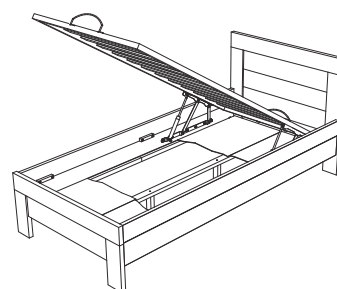



# WOODY SOFT LUX MEBL

KREKET OD PUNOD DRVETA BUKVE/SOLID WOOD BEDS

dimenzija/dimension: 215,5 x 169 x 85 cm  
dimenzija za dušek/dimension for mattress: 160 x 200 cm



**4 in 1**

1. Krevet od punog drveta/Solid wood beds
2. Dušek sa žičanim jezgrom 23 cm  
Mattress with bonnell spring 23cm
3. Velika kutija za posteljinu/Big bedstorage box
4. Dostupno i lako održavanje ispod kreveta/  
Easy available and always clean



Belo/White  
Sivi štof/Grey cloth



Hrast/Oak  
Bež štof/Beige cloth



Wenge  
Bež štof/Beige cloth

Made in  
**Serbia**



Oznaka  
odgovornog šumarstva

# WOODY BOX MEBL

KREKET OD PUNOD DRVETA BUKVE/SOLID WOOD BEDS

dimenzija/dimension: 215,5 x 169 x 85 cm  
dimenzija za dušek/dimension for mattress: 160 x 200 cm



**4 in 1**

1. Krevet od punog drveta/Solid wood beds
2. Dušek sa žičanim jezgrom 23 cm  
Mattress with bonnell spring 23cm
3. Velika kutija za posteljinu/Big bedstorage box
4. Dostupno i lako održavanje ispod kreveta/  
Easy available and always clean



Belo  
White



Bukva  
Beech



Trešnja  
Cherry



Hrast  
Oak



Wenge  
Wenge

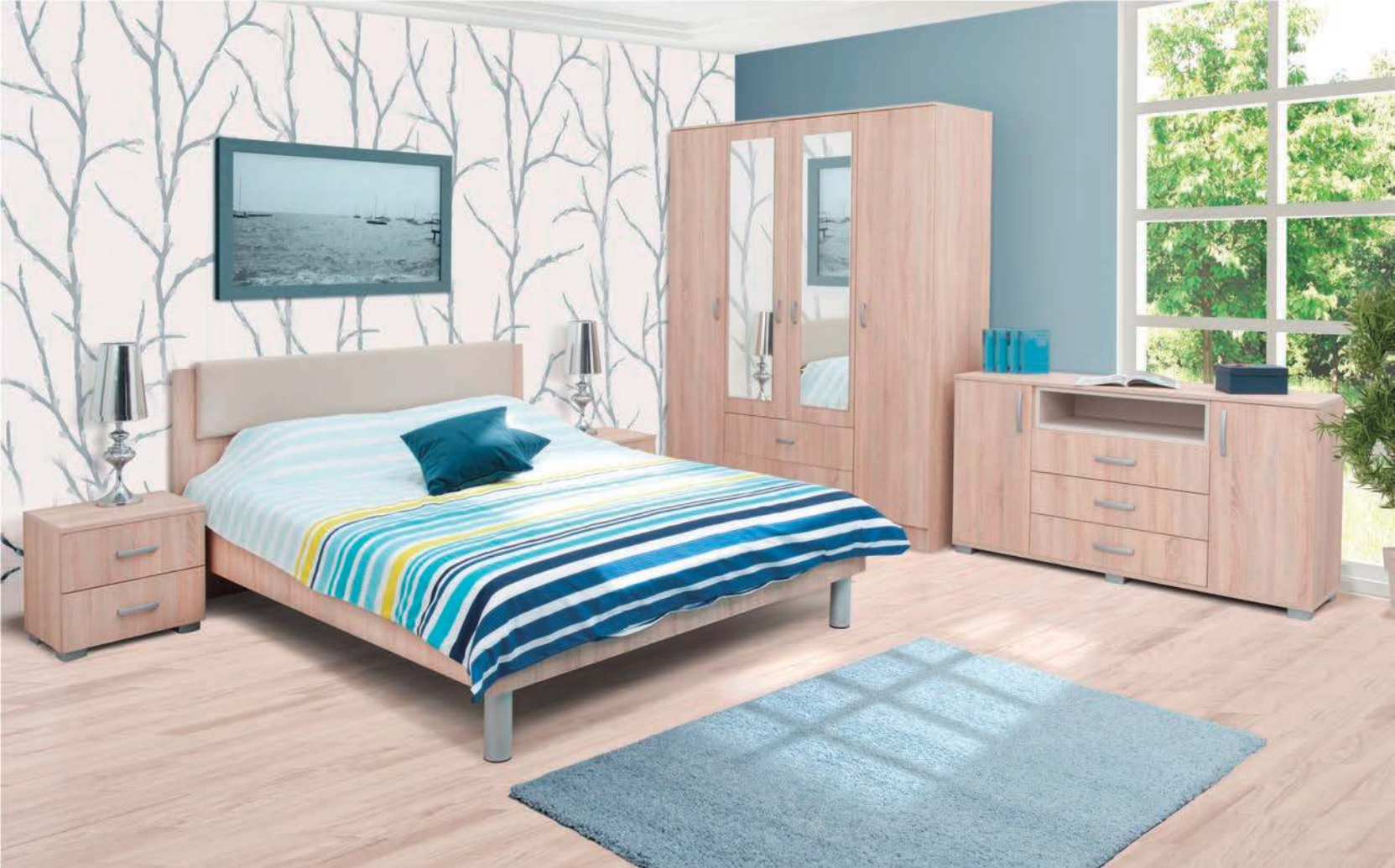

## INTRO NEW MEBL

BRAČNI KREKET / DOUBLE BED

dimenzija/dimension: 205 x 165 x 94 cm

dimenzija za dušek/dimension for mattress: 200 x 160 cm



ID **355109**  
belo / white



ID **355112**  
hrast-bardolino / oak-bardolino



ID **355146**  
snežni hrast / snow oak

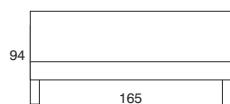
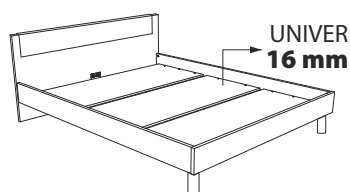

NAPOMENA: Podnica kreveta od univera je uključena u cenu. NOTE: Chipboard bed floor is included in the price.

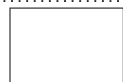

Belo/White  
Sivi štof/Grey cloth



Bardolino  
Bež štof/Beige cloth



Snežni hrast/Snow oak  
Sivi štof/Grey cloth







## DEČIJE SOBE/*CHILDREN ROOMS*

Jedan od najvažnijih elemenata u odrastanju svakog deteta predstavlja i životni prostor u kome ono provodi vreme. Bitno je da ovaj prostor odgovara njegovim godinama i potrebama, ali i da oslikava detetovu ličnost na što bolji način i zadovoljava svu njegovu znatiželju, kao i potrebu za funkcionalnošću, koja je svakom mališanu potrebna.

One of the most important elements in the growth of every child is the living space in which it spends time. It is important that this space corresponds to his age and needs, but also to reflect the child's personality in the best way and satisfies all his curiosity, as well as the need for the functionality that every child needs.



## NUMERO

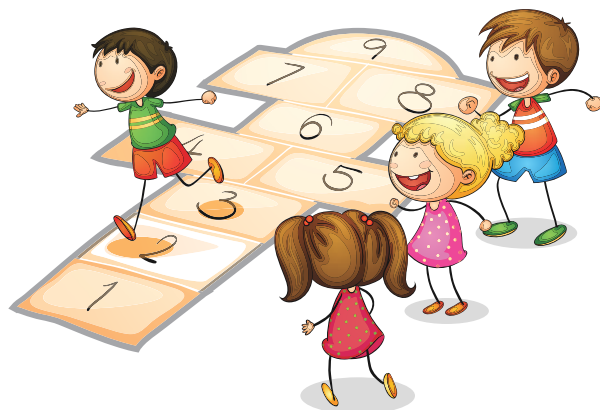





- |  |  |   |
|--|--|---|
| 1 Most kreveta / Bridge bed                | 6 O1V2F                                | 11 Komoda 2F niša / Cupboard 2F open box      |
| 2 Polica 80 / Shelf 80                     | 7 O2V4F niša / O2V4F open box          | 12 Klub sto / Club table                      |
| 3 Polica 40 / Shelf 40                     | 8 Most radnog stola / Bridge work desk | 13 Numero krevet 90 2F L / Numero bed 90 2F L |
| 4 O3V2F                                    | 9 Polica brojevi / Numbers shelf       | 14 Fioka kreveta / Bed drawer                 |
| 5 Ugaoni ormar / Corner closet             | 10 Radni sto / Work table              | 15 Kutija posteljina / Bedclothes box         |
| <hr/>                                      |  |   |
| 1 O2V2F                                    | 5 Polica 80 / Shelf 80                 | 9 Radni sto / Work table                      |
| 2 Numero krevet na sprat / Numero bunk bed | 6 O1V2F                                | 10 Komoda 2F niša / Cupboard 2F open box      |
| 3 Fioka kreveta / Bed drawer               | 7 O2V4F niša / O2V4F open box          | 11 Klub sto / Club table                      |
| 4 Most radnog stola / Bridge work desk     | 8 Bočna polica / Side shelf            |   |





1 Most kreveta / Bridge bed

2 Vitrina 1V / Showcase 1V

3 Kosa polica / Curve shelf

4 Ugaoni ormar / Corner closet

5 O2V2F

6 Bočna polica / Shide shelf

7 Klub st / Club table

8 Numero krevet 120 / Numero bed 120

9 Radni sto / Work table

10 Komoda 2F niša / Cupboard 2F open box

11 Polica brojevi / Numbers shelf

12 Polica 40 / Shelf 40

13 Polica 80 / Shelf 80

1 Most kreveta / Bridge bed

2 Most radnog stola / Bridge work desk

3 Vitrina 1V / Showcase 1V

4 Kosa polica / Curve shelf

5 Ugaoni ormar / Corner closet

6 O2V2F

7 O1V2F

8 O2V4F niša / O2V4F open box

9 Bočna polica / Shide shelf

10 Klub sto / Club table

11 Numero krevet 120 / Numero bed 120

12 Komoda 2F niša / Cupboard 2F open box

13 Radni sto / Work table

14 Polica brojevi / Numbers shelf

15 Komoda 3F niša / Cupboard 3F open box

16 Polica 80 / Shelf 80



**NUMERO**

1

2

3

4

5

6

7

8

9

16

14

13

12

11

15

10



**Numero O3V2F**  
120x52x217,5 cm  
ID J5850\*\*



**Numero O2V4F niša/  
Numero O2V4F nishe**  
80x52x217,5 cm  
ID J5840\*\*

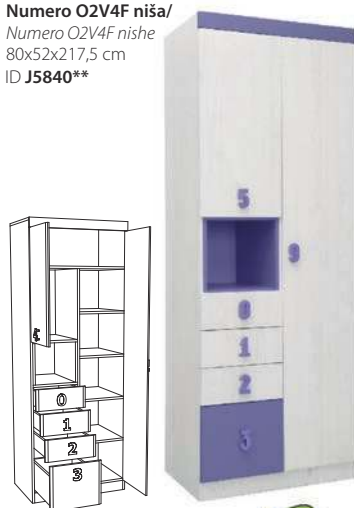

**Numero O2V2F**  
80x52x217,5 cm  
ID J5849\*\*



**Numero bočna polica**  
Numero shide shelf  
22x50x217,5 cm  
ID J5810\*\*



**Numero komoda 4F niša**  
Numero cupboard 4F nishe  
40x42x126,5 cm  
ID J5855\*\*



**Numero komoda 3F niša**  
Numero cupboard 3F nishe  
80x52x75 cm  
ID J5843\*\*



**Numero komoda 2F niša**  
Numero cupboard 2F nishe  
40x42x60 cm  
ID J5854\*\*



**Most radnog stola**  
Numero bridge work desk  
120x42x57,5 cm  
ID J5845\*\*

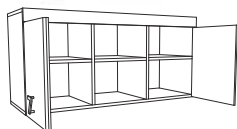

**Numero polica brojevi**  
Numero numbers shelf  
120x22x54 cm  
ID J5801\*\*

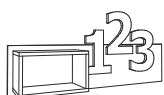

**Numero polica 40**  
Numero shelf 40  
40x20x23,5 cm  
ID J5811\*\*



**Numero polica 80**  
Numero shelf 80  
80x20x23,5 cm  
ID J5816\*\*

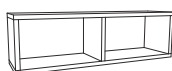

**Numero viseća niša**  
Numero hanging nishe  
40x40x35 cm  
ID J5806\*\*



**Numero radni sto**  
Numero work table  
120x60x75/93 cm  
ID J5804\*\*



**Numero TV komoda**  
Numero TV stands  
120x42x60 cm  
ID J5805\*\*

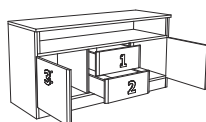

**Numero klub sto**  
Numero club table  
45x45x43 cm  
ID J5815\*\*



**Numero O1V2F**  
40x52x217,5 cm  
ID J5847\*\*

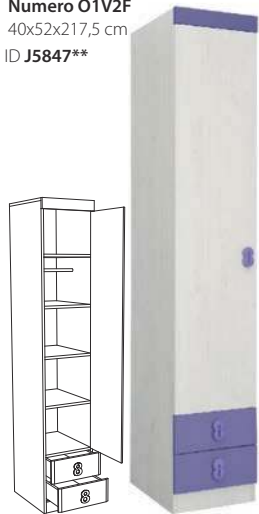

**Numero ugaoni ormar**  
Numero corner closet  
92,5/52x90,5/52x217,5 cm  
ID J5853\*\*

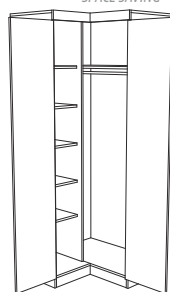
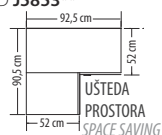

**Numero kosa polica**  
Numero cruve shelf  
Univerzalna L i D /  
Universal L&D  
40x40/50x217,5 cm  
ID J584054



**Numero vitrina 1V**  
Numero showcase 1V  
40x42x217,5 cm  
ID J5846\*\*



**Numero krevet na sprat**  
Numero bunk bed  
za dušek 90x200  
205x102,5x175 cm  
ID J584754

Leđa kreveta **ojačana** su lesonitom koji štiti zid od prljanja i pruža dodatnu **stabilnost** krevetu!

Bed backs are strengthened with hardboards, protecting the wall from dirt and providing extra stability for the bed at the same time.

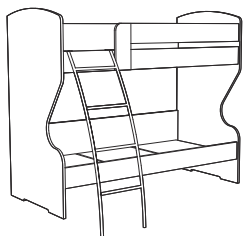

**Most kreveta/Numero bridge bed**  
205x42x57,5 cm  
ID J5844\*\*

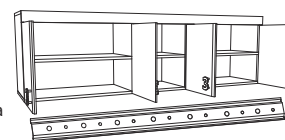

**Kačenje: metalna šina**  
Hanging metal rail

**Numero kutija posteljina**  
Numero bedclothes box  
30x102,5x92 cm  
ID J5802\*\*



**Numero krevet 90 2F D**  
Numero bed 90 2F D  
205x102,5x90 cm  
ID J5860\*\*D



\* Pod kreveta od univera **uključen je u cenu**

\* Bed floor of chipboard is included in price

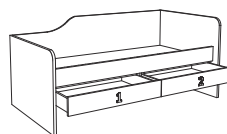

**Numero krevet 90 2F L**  
Numero bed 90 2F L  
205x102,5x90 cm  
ID J5860\*\*L



**Numero krevet 120/Numero bed 120**  
205x125x90 cm  
ID J584954



**Numero fioka kreveta/Numero bed drawer**  
199,5x94x23 cm  
ID J5800\*\*

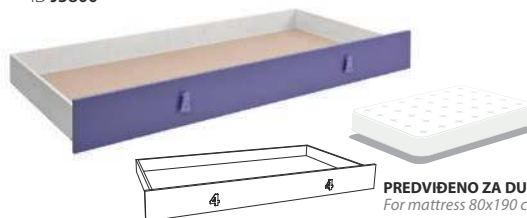

**PREDVIĐENO ZA DUŠEK 80x190 cm**  
For mattress 80x190 cm

**Ogradica kreveta/Bedding**  
160x30 cm  
ID ograda.kreveta



NAPOMENA Kompletna šifra elementa se dobija zamenom zvezdica \*\* sa dve cifre iz prikazanih dezena.  
NOTE: The complete code of an element is obtained by replacing stars\*\* with two digits of the displayed pattern.

NAPOMENA Pod kreveta je uključen u cenu. NOTE Bed floor of chipboard is included in price.  
NAPOMENA Letvice su uključene u cenu. NOTE Laths are included in price.

Korpus / Corps

Lice / Front

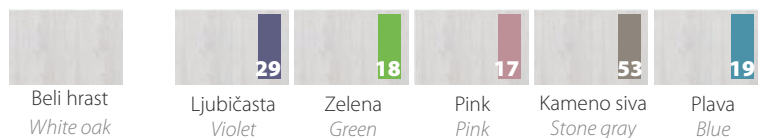

Beli hrast  
White oak

Ljubičasta  
Violet

Zelena  
Green

Pink  
Pink

Kameno siva  
Stone gray

Plava  
Blue

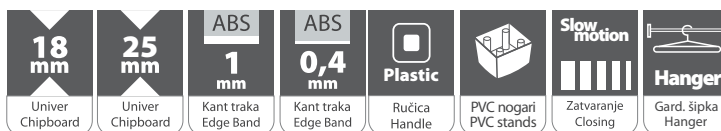

18 mm

Univer Chipboard

25 mm

Univer Chipboard

1 mm

Kant traka  
Edge Band

0,4 mm

Kant traka  
Edge Band

Plastic

Ručica  
Handle

PVC nogari  
PVC stands

Zatvaranje  
Closing

Slow motion

Gard, šipka  
Hanger





## HAPPY HRAST / HAPPY OAK

Česte su situacije kada se želje dece i tinejdžera ne poklapaju sa željama roditelja. Kompanija Matis je rešila da napravi savršeni kompromis i ponudi Vam dečije sobe Happy, dizajnirane tako da se dopadaju najmlađima, a funkcionalne toliko da mogu da prođu i testove odraslih. Dečije sobe Happy su prava sredina za formiranje i zdravih navika, na zabavan i bezbedan način.

*There are frequent situations where the desires of children and teenagers do not match with the wishes of parents. Company Matis has decided to make the perfect compromise and offer you Happy children's rooms, designed to appeal to the youngest and functional so that they can pass the most adult tests. Happy Room Happy Rooms are the right environment for creating the healthy habits, in a fun and safe way.*







- 1 Happy fioka KR / *Happy drawe KR*
- 2 Happy KR 90
- 3 Klub set "Pikolo" / *Club set Piccolo*

- 5 Happy KOM 1F
- 6 Happy KOMP STO / *Happy COMP desk*
- 4 Happy KOM 3F

- 7 Happy VEL POL / *Happy VEL shelf*
- 8 Happy O2V

- 1 Happy fioka KR / *Happy drawe KR*
- 2 Happy KR 90
- 3 Happy O2V2F

- 4 Happy KOM 1F
- 5 Happy POL 100
- 6 Happy KOMP STO / *Happy COMP desk*

- 7 Happy V POL 80 x 190
- 8 Happy KOM 3F







1 Happy O POL 40 x 153

2 Happy KOMP STO / Happy COMP desk

3 Happy POL 100

4 Happy V POL 40 x 190

5 Happy O2V2F

6 Krevet na sprat / Bunk bed

7 Happy fioka KR / Happy drawe KR

8 Happy O1V

9 Happy TV KOM - klub sto/Club table

1 Happy KR BOK

2 Happy fioka KR / Happy drawe KR

3 Matisan dušek/Mattress 80 x 190

4 Happy KL POL 80 x 153

5 Happy KOM 1F

6 Happy VEL POL

7 Happy KOMP STO / Happy COM desk

8 Happy O2V





**Happy O3V2F**  
125 x 54 x 220 cm  
ID J492140



**Happy O2V**  
85 x 54 x 220 cm  
ID J491940



**Happy O2V2F**  
85 x 54 x 220 cm  
ID J492040

25 mm  
Univer  
Chipboard

ABS  
1 mm  
Kant traka  
Edge Band



**Happy KL POL 80 x 153**  
*Happy KL POL 80 x 153 shelf*  
80 x 38 x 153  
ID J491640



**Happy VEL POL**  
100 x 32 x 190  
ID J491540

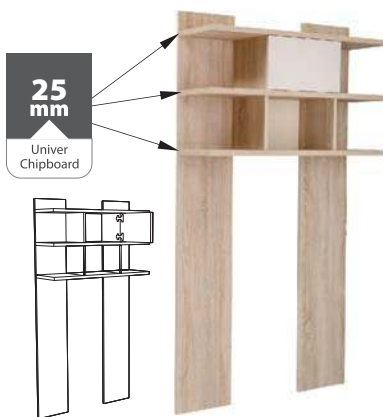

**Happy POL 100**  
*Happy POL 100 shelf*  
100 x 22 x 18,5 cm  
ID J491012



**Happy KOM STO**  
*Happy COMP desk*  
100 x 50 x 75 cm  
ID J490412



**Happy KOM 3F**  
78 x 52 x 88 cm  
ID J490312



**Happy KOM 1F**  
42 x 38 x 75 cm  
ID J490112



**Happy N ORM**  
42 x 38 x 52 cm  
ID J490212



**Happy TV KOM/ klub sto**  
*Happy TV KOM / club table*  
100 x 50 x 50 cm  
ID J490512



**Pikolo klub set**  
*Piccolo club set*  
45 x 38 x 48 cm  
ID 210512



**Happy O1V**  
45 x 54 x 220 cm  
ID J491840



**Happy V POL 80 x 190**  
Happy V POL 80 x 190 / shelf  
80 x 38 x 190 cm  
ID J491312



**Happy V POL 40 x 190**  
Happy V POL 40 x 190 / shelf  
42 x 38 x 190 cm  
ID J491212



**Happy O POL 40 x 153**  
Happy O POL 40 x 153 / shelf  
42 x 38 x 153 cm  
ID J491112



**Happy KR 120**  
126 x 206 x 74,5 cm  
ID J490812



**Happy KR 90**  
95 x 206 x 72 cm  
ID J490712

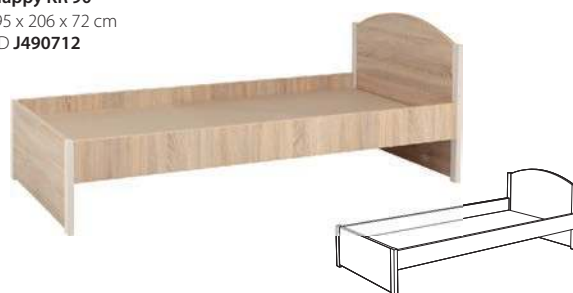

**Happy KR BOK**  
95 x 206 x 63 cm  
ID J490612



**Happy fioka KR**  
Happy drawe KR  
199 x 91 x 18 cm  
ID J490912



**Krevet na sprat**  
Bunk bed  
205 x 96,4 x 173,5 cm  
ID J492312

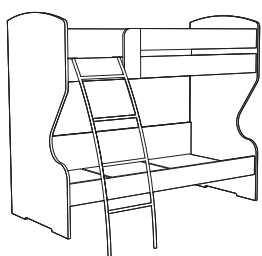

Leda kreveta **ojačana** su lesonitom koji **štiti** zid od prljanja i pruža dodatnu **stabilnost** krevetu!

Bed backs are strenghten with hardboards, protecting the wall from dirt and providing extra stability for the bed at the same time.



**25 mm**  
Univer Chipboard

**ABS**  
**2 mm**  
Kant traka Edge Band

NAPOMENA Pod kreveta je uključen u cenu.  
NOTE Bed floor of chipboard is included in price.

Korpus / Corps



Hrast/  
Oak

Lice / Front



Šampanj/  
Champagne







## HAPPY BELO/HAPPY WHITE

---

Svetli i veseli tonovi Happy sobe unose svetlost u Vaš dom. Dodatno osveženje donose i stakla u boj na frontovima. Veliki broj kombinacija 21 elementa je argument koji se ne može zanemariti u odabiru Vaše sobe.

*Bright and cheerful tones of the Happy room entered light in your home. Glass fragments in three designs bringing additional refreshments! A large number of combinations of twenty two elements is an argument that can not be ignored in the selection of your room.*







- 1 Happy KR BOK
- 2 Happy POL 100
- 3 Happy O1V
- 4 Happy VEL POL

- 5 Happy TV KOM klub sto/ Club table
- 6 Pikolo klub set / Piccolo club set
- 7 Happy O2V2F
- 8 Happy O POL 40 x 153

- 9 Happy KOMP STO/ Comp desk
- 10 Happy KL POL 80 x 153
- 11 Happy fioka KR / Happy drawe KR

- 1 Happy KOM 3F
- 2 Happy POL 100
- 3 Happy TV KOM / klub sto/ Club table

- 4 Happy O2V2F
- 5 Pikolo klub set / Piccolo club set

- 6 Krevet na sprat / Bunk bed
- 7 Happy fioka KR / Happy drawer KR







- 1 Krevet na sprat / Bunk bed
- 2 Happy O2V2F / Happy O2V2F
- 3 Happy TV KOM klub sto/Club table
- 4 Happy POL 100 / Happy POL 100
- 5 Happy O POL 40 x 153
- 6 Happy KOMP STO/Comp desk
- 7 Happy fioka KR / Happy drawer KR

- 
- 1 Happy KR BOK / Happy KR BOK
  - 2 Happy POL 100 / Happy POL 100
  - 3 Happy V POL 80 x 190
  - 4 Happy VEL POL / Happy VEL POL
  - 5 Happy KOMP STO/Comp desk
  - 6 Happy V POL 40 x 190
  - 7 Happy O1V / Happy O1V
  - 8 Happy O3V2F / Happy O3V2F
  - 9 Happy TV KOM klub sto/Club table
  - 10 Happy fioka KR / Happy drawer KR





**Happy O3V2F**  
125 x 54 x 220 cm  
ID 4921\*\*

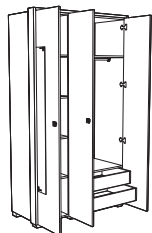

**Happy O2V**  
85 x 54 x 220 cm  
ID 4919\*\*

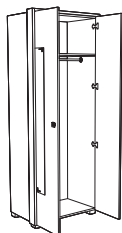

**Happy O2V2F**  
85 x 54 x 220 cm  
ID 4920\*\*



**Happy KL POL 80 x 153**  
*Happy KL POL 80 x 153 shelf*  
80 x 38 x 153 cm  
ID 4916\*\*



**Happy VEL POL**  
100 x 32 x 190 cm  
ID 4915\*\*



**Happy POL 100/Happy POL 100 shelf**  
100 x 22 x 18,5 cm  
ID J491009

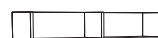

**Happy KOMP STO**  
*Happy COMP desk*  
100 x 50 x 75 cm  
ID 490409

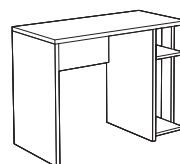

**Happy KOM 3F**  
78 x 52 x 88 cm  
ID 490309



**Happy KOM 1F**  
42 x 38 x 75 cm  
ID 490109

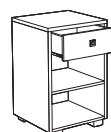

**Happy NORM**  
42 x 38 x 52 cm  
ID 490209

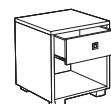

**Happy TV KOM / klub sto**  
*Happy TV KOM / club table*  
100 x 50 x 50 cm  
ID 490509

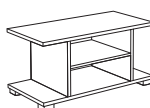

**Pikolo klub set/Piccolo club set**  
45 x 38 x 48 cm  
ID J210509

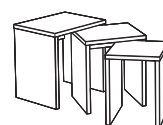

**Happy O1V**  
45 x 54 x 220 cm  
ID **4918\*\***

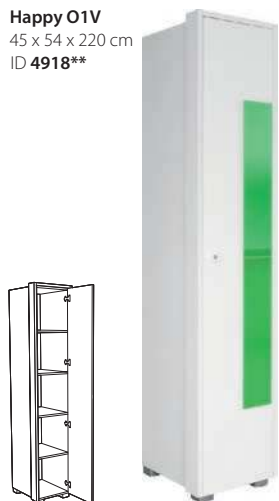

**Happy V POL 80 x 190**  
Happy V POL 80 x 190 / shelf  
80 x 38 x 190 cm  
ID **491309**



**Happy V POL 40 x 190**  
Happy V POL 40 x 190 / shelf  
42 x 38 x 190 cm  
ID **491209**



**Happy O POL 40 x 153**  
Happy O POL 40 x 153 / shelf  
42 x 38 x 153 cm  
ID **491109**



**Happy KR 120**  
126 x 206 x 74,5 cm  
ID **J490809**



**Happy KR BOK**  
95 x 206 x 63 cm  
ID **J490609**



**Happy KR 90**  
95 x 206 x 72 cm  
ID **J490709**



**Happy fioka KR/Happy drawe KR**  
199 x 91 x 18 cm  
ID **J490909**



**PREDVIĐENO ZA DUŠEK 80x190 cm**  
For mattress 80x190 cm

**Krevet na sprat/Bunk bed**  
205 x 96,4 x 173,5 cm  
ID **J492309**

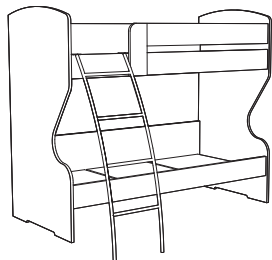

Leđa kreveta **ojačana** su lesonitom koji **štiti** zid od prljanja i pruža dodatnu **stabilnost** krevetu!

Bed backs are strengthened with hardboards, protecting the wall from dirt and providing extra stability for the bed at the same time.

**25 mm**  
Univer Chipboard



NAPOMENA Kompletna šifra elementa se dobija zamenom zvezdica \*\* sa dve cifre iz prikazanih dezena.  
NOTE: The complete code of an element is obtained by replacing stars\*\* with two digits of the displayed pattern.

NAPOMENA Pod kreveta je uključen u cenu. NOTE Bed floor of chipboard is included in price.  
NAPOMENA Letvice su uključene u cenu. NOTE Slats are included in the price.

Korpus / Corps



Belo  
White

Lice / Front



Belo sjaj  
White gloss

\*\* Staklo / glass



**18**

Zeleno  
Green



**22**

Sivo  
Gray

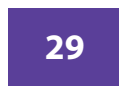

**29**

Lila  
Violet

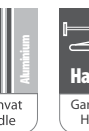
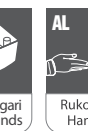





## KOMPJUTERSKI STOLOVI / *COMPUTER'S DESK*

---

Eksplzivni razvoj tehnologije nameće potrebu za sve bržim obavljanjem radnih zadataka, što je moguće postići jedino u pravilno konfigurisanom radnom okruženju. Osnovna karakteristika dobro dizajniranog kompjuterskog stola je njegova maksimalna funkcionalnost. Kompjuterski stolovi kompanije Matis konstruisani su tako da vrlo brzo postaju produžena ruka korisnika.

*The explosive development of technology imposes the need for faster job performance, which can be achieved only in a properly configured work environment. The basic characteristic of a well-designed computer table is its maximum functionality. Matis's computer tables have been designed so that they quickly become an extended user's hand.*

# HAPPY 18 mm

dimenzije/dimension: 100 x 50 x 75 cm



ID 492403  
trešnja / cherry



ID 492446  
snežni hrast / snow oak



ID 492452  
tobako / tobacco



Trešnja  
Cherry

Snežni hrast  
Snow oak

Tobako  
Tobacco



# ANA 3F

dimenzije/dimension: 130 x 60 x 75 cm



ID 4703\*\*  
belo / white



ID 4703\*\*  
hrast / oak

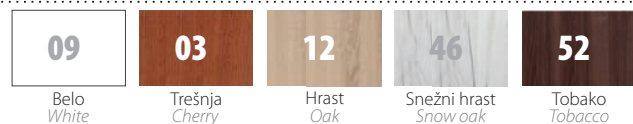
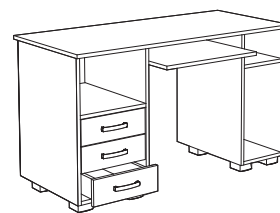

09  
Belo  
White

03  
Trešnja  
Cherry

12  
Hrast  
Oak

46  
Snežni hrast  
Snow oak

52  
Tobako  
Tobacco

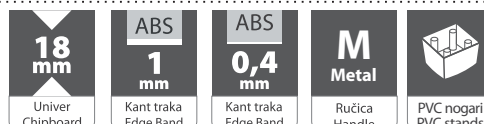

# DIONIS

dimenzije/dimension: 130 x 60 x 75 cm



ID 4702\*\*  
snežni hrast / snow oak



ID 4702\*\*  
tobako / tobacco

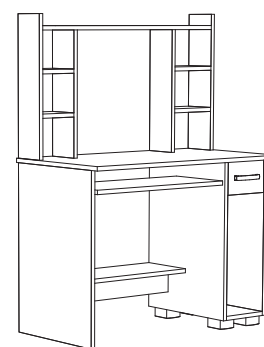

NAPOMENA Kompletna šifra elementa se dobija zamenom zvezdica \*\* sa dve cifre iz prikazanih dezena.  
NOTE: The complete code of an element is obtained by replacing stars\*\* with two digits of the displayed pattern.

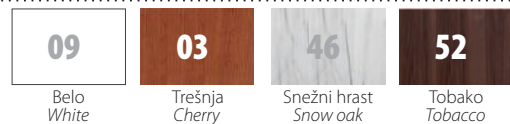

09  
Belo  
White

03  
Trešnja  
Cherry

46  
Snežni hrast  
Snow oak

52  
Tobako  
Tobacco

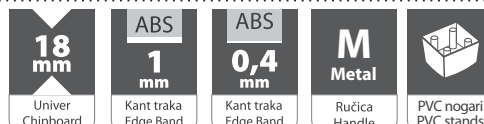





**VRHUNSKI KVALITET • SAVREMEN DIZAJN • PRISTUPAČNE CENE**

*TOP QUALITY • CONTEMPORARY DESIGN • AFFORDABLE PRICES*

Kvalitet leži u detaljima, koji nisu uvek očigledni oku posmatrača, a direktan su rezultat pažljivo konstruisanog i sprovedenog inženjeringa unutar naših proizvodnih procesa. Projektovan tako da ispuni sve zahteve tržišta, fleksibilan tehnološki sistem Matisa omogućava proizvodnju velikog broja raznorodnih proizvoda, u manjim ili većim serijama, sa maksimalnom produktivnošću u oba slučaja. Proizvodni program čine:

- kuhinje i trpezarijski stolovi
- nameštaj za dnevne boravke
- nameštaj za spavaće sobe
- nameštaj za dečije sobe
- predsoblja i cipelari

Profilisali smo se, pre svega, u kvalitetnog i pouzdanog proizvođača nameštaja, o čemu mogu da posvedoče mnogobrojni zadovoljni kupci i saradnici. Uspesno saradjujemo sa preko 150 distributera u zemlji i svetu i posedujemo 4 predstavništva u inostranstvu.

Izvozimo u preko 15 zemalja Evrope. Aktivno održavamo i proširujemo svoju razgranatu mrežu maloprodajnih objekata širom zemlje, garantujući kupcima rok isporuke od 7 dana za Matis proizvode.

*Quality in details, not necessarily in the eyes of the beholder, are result of carefully constructed and implemented engineering inside our production processes. Projected to fulfill all market needs, flexible technological system of company Matis is providing high capacity production of great number of various products in smaller and bigger series, with the maximum of productivity in both cases.*

- *kitchens and dinning tables*
- *livingrooms furniture*
- *bedrooms furniture*
- *children rooms furniture*
- *hall units and shoe cabinets*

*We are, above all, recognized as reliable high quality producer of furniture, that numerous satisfied customers and partners may confirm. We are cooperating successfully with more than 150 distributors in the country and abroad, together with our 4 representative offices abroad.*

*We are exporting to more than 15 countries in Europe. We actively maintain and expand our retail network all over the country, and we guarantee to our customers delivery time of 7 days for Matis products.*





# Matis Wood

## Kompletna fabrička linija za proizvodnju nameštaja od masiva

*Factory line for of solid wood furniture production*

Koristeći blagodeti prirodnih resursa Srbije, a u skladu sa najsavremenijim tehnologijama, koje podrazumevaju lasersko zadavanje mera pri rezanju, primenu najnovije tehnologije sušenja, preradu CNC tehnologijom i farbanje lakiranjem na automatizovanim linijama, sigurni smo da će svaki proizvedeni komad zadovoljiti najviše standarde kvaliteta i najrazličitije ukuse naših kupaca.

Proizvodni program čine:

- nameštaj za dnevne boravke
- nameštaj za spavaće sobe
- nameštaj za trpezarije

*Using the very best of natural resources of Serbia, in accordance with top modern technological systems of laser measuring during the cutting phase, implementing top modern technology of drying and processing on CNC technology with lacquering on automatized lines, we are absolutely certain that each produced item will fully satisfy the highest quality standards and various tastes of our customers.*

*Production assortment consists of:*

- livingrooms furniture
- bedrooms furniture
- dining rooms furniture

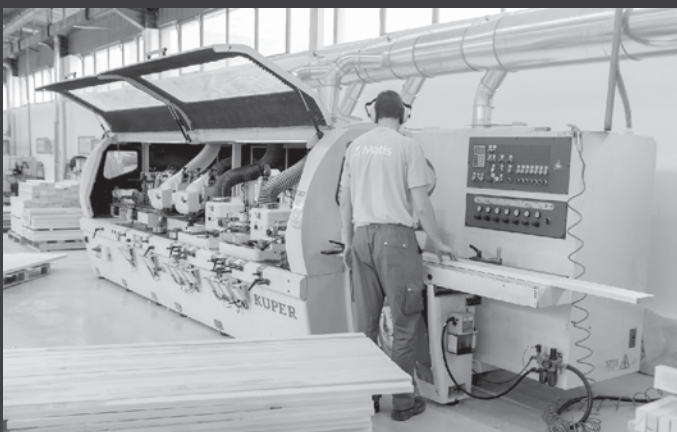



Osnovna delatnost firme Matis je serijska proizvodnja nameštaja od pločastih materijala. Obezbeđenje kvalitetnih materijala, upošljavanje visoko stručnih ljudskih potencijala, kao i primena savremenih tehnologija u proizvodnji, bili su principi početne strategije razvoja firme. Vođen tim principima, Matis je uspešno dizajnirao, projektovao i plasirao na tržište asortiman od preko 1000 proizvoda. Proizvodnja je organizovana kroz fleksibilan tehnološki sistem sa kompjuterski upravljanim mašinama. Kao rezultat istrajnosti u primeni početnih principa, danas se naši proizvodi prepoznaju povrhunskom kvalitetu, savremenom dizajnu i veoma pristupačnim cenama.

*The main activity of MATIS company is serial production of chipboard furniture. The basic principles of our developmental strategy are usage of high quality materials, employment of well educated human potentials, as well as application of modern technologies in the production process. With the guidance of these principles MATIS has successfully designed, produced and placed on the market more than 1000 products. Production is well organised, through flexible technological system with CNC technology. As the result of our persistence in the following of the quoted principles, our products are nowadays recognised by high quality, modern design and very affordable prices.*



**15 000 m<sup>2</sup>**  
magacina repromaterijala  
*raw material warehouses*

**5** proizvodnih linija  
*production lines*  
**20 000 m<sup>2</sup>**

**25 000 m<sup>2</sup>**  
magacina gotovih proizvoda  
*final product warehouses*

Prateći zahteve tržišta u pogledu kvaliteta, cena i količina proizvoda, tehnološki sistem firme **Matis** projektovan je da isprati najsloženije zahteve tržišta.

Projektovan kao fleksibilni tehnološki sistem omogućava proizvodnju velikog broja raznorodnih proizvoda u manjim ili većim serijama, sa maksimalnom produktivnošću u oba slučaja.

*By following market demands in terms of quality, prices and quantity of products, technological system of Matis Company is designed to follow most complex market demands.*

*Designed as a flexible technological system it allows producing of a numerous various products in smaller or bigger series, with the maximum productivity in both cases.*

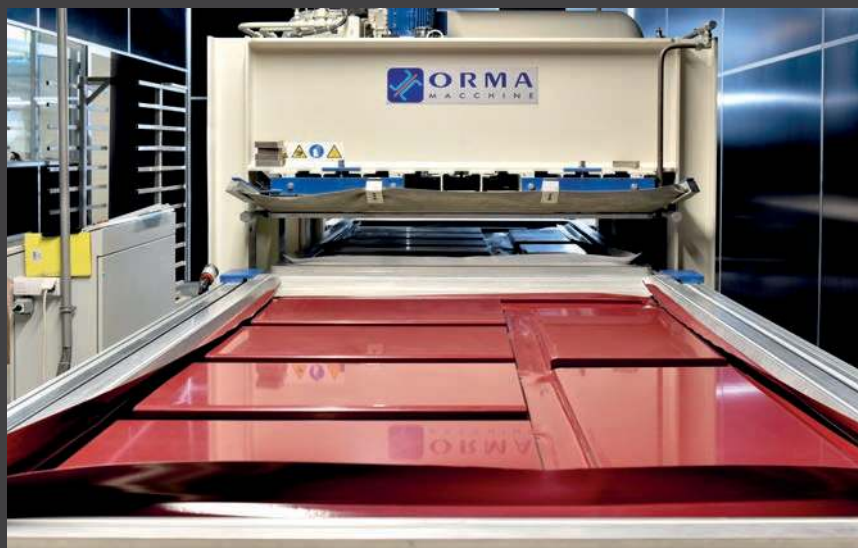

ITALIJANSKA VAKUUM TEHNOLOGIJA IZRADE FRONTOVA OD MEDIJAPANA  
ITALIAN VACUUM TECHNOLOGY PREPARATION FRONT MDF



Kompletan podsistem mašina sastoji se isključivo od kompjuterski upravljanih mašina renomiranih svetskih proizvođača. Podsistem mašina integrisan je sa transportnim sistemima tako da su vremena obrade i pomoćna vremena minimalizovana što donosi trenutno najvišu produktivnost u industriji nameštaja. Trenutno se tehnološki sistem sastoji od 5 proizvodnih linija (20.000 m<sup>2</sup>) koje se svake godine, prateći svetske trendove, dopunjuju ili menjaju isključivo novim mašinama većeg kapaciteta i sa većim stepenom automatizacije proizvodnog procesa.

Upravljanje kvalitetom proizvoda vrši se, kako procesnim kontrolama kvaliteta od strane kontrolora kvaliteta uzorkovnjem, tako i izlaznom kontrolom gotovih proizvoda.

Magacinski prostori repromaterijala od 15.000 m<sup>2</sup> i gotovih proizvoda od 25.000 m<sup>2</sup>, kao i lager od 2.000.000 € garantuju kontinuitet isporuke Matisovih proizvoda.

*Complete machine subsystem consists exclusively of computer-controlled machines made by renowned world manufacturers. The machine subsystem is integrated with transport systems so that processing time and additional time are minimized, which is currently bringing the highest productivity in the furniture industry. Currently, the technological system consists of 5 production lines (20.000 m<sup>2</sup>), that each year, by following world trends, are supplemented or changed only for new machines with higher capacities and with higher degree of automation of the production process.*

*Management quality of products is done by quality control by sample quality controller, as well as by output control of final products.*

*Storage spaces of raw material of 15.000 m<sup>2</sup> and 25.000 m<sup>2</sup> of final products, as well as the stock of 2.000.000 euros guarantee continuity of supply of Matis products.*